

Table of Contents

1. Introduction	5
1.1. Box Content	6
1.2. Minimum System Requirements	7
1.2.1. Windows Users	7
1.2.2. Mac Users	7
1.3. Hard Drive Heat Management	8
1.4. Views of the 2big Network	9
1.5. Ethernet Cable	10
2. Setting Up Your LaCie 2big Network	11
2.1. Turning On the 2big Network	12
2.2. Connecting the Ethernet Cable	13
2.3. Connecting Using LaCie Network Assistant	14
2.4. Configuring the LaCie 2big Network on a Network Without a DHCP Server	16
2.5. Unmounting 2big Network Volumes	17
3. Accessing & Managing Files	18
3.1. Accessing Shared Folders	18
3.1.1. Other Connection Methods	19
3.2. FTP Access to Shares	21
3.3. Administration Page – Browse	22
3.3.1. Uploading Files	22
3.3.2. Downloading Files	23
3.3.3. Deleting Files	23
3.3.4. Logging Out	23
3.4. Connecting External Hard Disks	24
4. Administering Your LaCie 2big Network	25
4.1. Accessing the Administration Page	26
4.1.1. Setting the Display Language	27
4.1.2. Administration Home Page	27
4.2. Users	28
4.2.1. Adding Users	29
4.2.2. Setting User Access to Shares	30
4.2.3. Setting Group Membership	30
4.2.4. About Access Privileges	31
4.2.5. Deleting User Accounts	31
4.2.6. Editing User Accounts	31
4.3. Groups	32
4.3.1. Adding Groups	32
4.3.2. Setting Group Access to Shares	33
4.3.3. Deleting Groups	33
4.3.4. Editing Groups	33
4.4. Shares	34
4.4.1. Creating Shares	34
4.4.2. Deleting Shares	35
4.4.3. Editing Shares	35
4.5. System	36
4.5.1. Active Directory	36
4.5.2. Configuration	37
4.5.3. Network	38

4.5.4. RAID	39
4.5.5. Disks	40
4.5.6. Status	42
4.5.7. Maintenance	42
4.5.8. System Log	45
4.5.9. Wake on LAN (WOL)	46
4.6. Download	47
4.7. Backup	48
4.8. Browse	49
4.9. Import (Snapshot)	49
4.10. Multimedia	50
5. RAID and Disks	51
5.1. Changing the RAID Level	51
5.2. RAID 0	52
5.3. RAID 1	53
5.4. Installing a New Disk	54
6. LED Indicators	55
7. Email Notification Triggers	56
8. Troubleshooting	57
9. Contacting Customer Support	59
8.1. LaCie Technical Support Contacts	60
10. Warranty Information	61

Copyrights

Copyright © 2009 LaCie. All rights reserved. No part of this publication may be reproduced, stored in a retrieval system, or transmitted in any form or by any means, electronic, mechanical, photocopying, recording or otherwise, without the prior written consent of LaCie.

Trademarks

Apple, Mac, and Macintosh are registered trademarks of Apple Computer, Inc. Microsoft, Windows 98, Windows 98 SE, Windows 2000, Windows Millennium Edition, Windows XP and Windows Vista are registered trademarks of Microsoft Corporation. Other trademarks mentioned in this manual are the property of their respective owners.

Changes

The material in this document is for information only and subject to change without notice. While reasonable efforts have been made in the preparation of this document to assure its accuracy, LaCie assumes no liability resulting from errors or omissions in this document, or from the use of the information contained herein. LaCie reserves the right to make changes or revisions in the product design or the product manual without reservation and without obligation to notify any person of such revisions and changes.

Canada Compliance Statement

This Class A digital apparatus meets all requirements of the Canadian Interference-Causing Equipment Regulations.

ROHS Compliance

This product is ROHS compliant (European Directive 2002/95/EC on the Restriction of Hazardous Substances).

FCC Statement



This device complies with Part 15 of the FCC Rules. Operation is subject to the following conditions:

- ◆ The devices may not cause harmful interference
- ◆ The devices must accept any interference received, including interference that may cause undesired operation.

NOTE: This equipment has been tested and found to comply with the limits for a Class B digital device, pursuant to Part 15 of the FCC Rules. These limits are designed to provide reasonable protection against harmful interference in a residential installation. This equipment generates, uses and can radiate radio frequency energy and, if not installed and used in accordance with the instructions, may cause harmful interference to radio communications. However, there is no guarantee that interference will not occur in a particular installation. If this equipment does cause harmful interference to radio or television reception, which can be determined by turning the equipment off and on, the user is encouraged to try and correct the interference by one or more of the following measures:

- ◆ Reorient or relocate the receiving antenna.
- ◆ Increase the separation between the equipment and receiver.
- ◆ Connect the equipment into an outlet on a circuit different from that to which the receiver is connected.
- ◆ Consult the dealer or an experienced radio/TV technician for help.

Modifications to this product not authorized by LaCie could void the FCC & Industry Canada regulations and negate your authority to operate the product.

CE Manufacturer's Declaration for CE Certification

We, LaCie, solemnly declare that this product conforms to the following European standards: Class B EN60950, EN55022, EN50082-1, EN61000-3-2

With reference to the following conditions: 73/23/EEC Low Voltage Directive; 89/336/EEC EMC Directive



This symbol on the product or on its packaging indicates that this product must not be disposed of with your other household waste. Instead, it is your responsibility to dispose of your waste equipment by handing it over to a designed collection point for the recycling of waste electrical and electronic equipment. The separate collection and recycling of your waste equipment at the time of disposal will help to conserve natural resources and ensure that it is recycled in a manner that protects human health and the environment. For more information about where you can drop off your waste equipment for recycling, please contact your local city office, your household waste disposal service, or the shop where you purchased the product.

CAUTION: A shielded-type power cord is required in order to meet FCC emission limits and also to prevent interference to the nearby radio and television reception. It is essential that only the supplied power cord be used.

Health and Safety Precautions

- ◆ Only qualified persons are authorized to carry out maintenance on this device.
- ◆ Read this User Manual carefully and follow the correct procedure when setting up the device.
- ◆ Do not open your LaCie 2big Network or attempt to disassemble or modify it. Never insert any metallic object into the drive to avoid any risk of electrical shock, fire, short-circuiting or dangerous emissions. Your LaCie 2big Network contains no user-serviceable parts. If it appears to be malfunctioning, have it inspected by a qualified LaCie Technical Support representative.
- ◆ Never expose your device to rain, or use it near water, or in damp or wet conditions. Never place objects containing liquids on the LaCie 2big Network, as they may spill into its openings. Doing so increases the risk of electrical shock, short-circuiting, fire or personal injury.
- ◆ Power requirements 100-240 V~, 1.44 A, 50-60 Hz, (supply voltage fluctuations not exceeding $\pm 10\%$ of the nominal and transient over-voltages according to over-voltage category II).

General Use Precautions

- ◆ Do not expose your device to temperatures outside the range of 5° C to 35° C (41° F to 95° F); or to operational humidity beyond 5-80%, non-condensing, or non-operating humidity beyond 10-90%, non-condensing. Doing so may damage it or disfigure its casing. Avoid placing your device near a source of heat or exposing it to sunlight (even through a window). Inversely, placing your device in an environment that is too cold or humid may damage the unit.
- ◆ Always unplug the device from the electrical outlet if there is a risk of lightning or if it will be unused for an extended period of time. Otherwise, there is an increased risk of electrical

shock, short-circuiting or fire.

- ◆ Use only the power supply shipped with the device.
- ◆ Do not use the device near other electrical appliances such as televisions or radios. Doing so may cause interference which will adversely affect the operation of the other products.
- ◆ Do not place the device near sources of magnetic interference, such as computer displays, televisions or speakers. Magnetic interference can affect the operation and stability of your device.
- ◆ Never use excessive force on your device. If you detect a problem, see the Troubleshooting section in this manual.

IMPORTANT INFO: Any loss, corruption or destruction of data while using a LaCie drive is the sole responsibility of the user, and under no circumstances will LaCie be held liable for the recovery or restoration of this data. To help prevent the loss of your data, LaCie highly recommends that you keep **TWO** copies of your data; one copy on your external hard disk, for instance, and a second copy either on your internal hard disk, another external hard disk or some other form of removable storage media. LaCie offers a complete line of CD and DVD drives. If you would like more information on backup, please refer to our website.

IMPORTANT INFO: 1GB = 1,000,000,000 bytes. 1TB = 1,000,000,000,000 bytes. Once formatted, the actual available storage capacity varies depending on operating environment (typically 10-15% less).

1. Introduction

Congratulations on your purchase of a LaCie 2big Network. Designed to satisfy the data sharing and backup needs of small offices, the LaCie 2big Network represents the new generation of shared storage with security.

RAID Flexibility

RAID technology is one of the best means to protect your data, while providing greater data integrity and availability than standard hard disk storage. With the ability to provide single error detection and redundant information to recover the original if a disk fails, a RAID system is an ideal means to safe-guard valuable data while also stream-lining performance.

Superior Design

The advanced heat-dissipating metal casing and thermoregulated fan ensure long-lasting reliability and quiet operation. The 2big Network can be stacked or rackmounted to conform to every work environment. The large glowing blue button adds more than character – it functions as a 1-click data-sharing button for automatic file transfers from a USB key. Just push the button; your data is automatically saved to the d2 Network.

Easy Setup & Access

The new user-friendly LaCie Network Assistant makes setup simple and enables accessing, mapping and configuring the drives on your office's network. The 2big Network's compatibility with Mac®, Windows® and Linux machines without having to install drivers make it the ideal file-sharing solution for small businesses.



Quick Links

Click a topic:

- ◆ Setting Up Your LaCie 2big Network
- ◆ Accessing & Managing Files
- ◆ RAID and Disks
- ◆ Troubleshooting

1.1. Box Content

Your LaCie 2big package contains the system tower and an accessories box containing items 2-6, listed below:

1. LaCie 2big RAID system tower with two trayless, hot-swappable hard drives
2. Cat 5E Ethernet cable
3. Power supply
4. Utilities CD-ROM
5. Quick Install Guide
6. 2-in-1 RAID mode change and drive lock tool

IMPORTANT INFO: Please save your packaging. In the event that the 2big Network should need to be repaired or serviced, it must be returned in its original packaging.

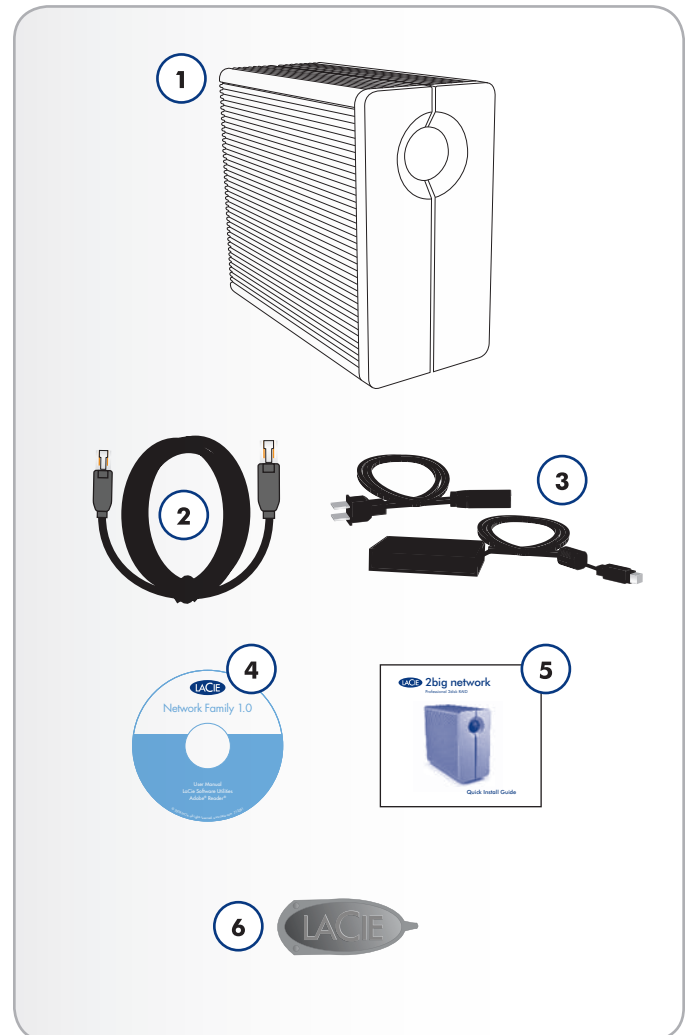

1.2. Minimum System Requirements

1.2.1. Windows Users

- ◆ Windows 2000, Windows XP or Windows Vista
- ◆ 500MHz processor or higher
- ◆ 512MB RAM or greater
- ◆ Ethernet switch or hub (10/100 or better)
- ◆ Web browser (Internet Explorer®, Firefox™)

1.2.2. Mac Users

- ◆ Mac OS X 10.2
- ◆ 500 MHz G4 or higher, G5, Intel Core Duo or Intel Core 2 Duo
- ◆ 512MB RAM or greater
- ◆ Ethernet switch or hub (10/100 or better)
- ◆ Web browser (Internet Explorer®, Safari™, Firefox™)

IMPORTANT INFO: The 2big Network's performance can be affected by such external forces as network activity, hardware, distance and setup.

IMPORTANT INFO: For optimal performance, use a Gigabit Ethernet router and a Gigabit Ethernet board in your host computer.

1.3. Hard Drive Heat Management

Heat Dissipation Design

The LaCie 2big Network's metal body is ideal for naturally dissipating internal drive heat. Its unique design actually draws heat away from the internal drives toward the external casing. This feature takes heat away from the internal drive, keeping it safe and prolonging its life and reliability. **As a consequence, it is normal for the external casing to be hot to the touch.** Please make sure that the vents on the back bezel are not obstructed so that there is a natural airflow across the casing.

Vertical, Horizontal & Rackmount

Heat dissipation is maximized when the drive is in the vertical position. If you have several LaCie drives stacked on each other, please remember to attach the included rubber feet on the under side of your drives. This will allow for some airflow between your drives so that the heat dissipation can work effectively. LaCie does not recommend stacking or racking more than 3 drives on top of each other, especially if these drives are turned ON simultaneously.

Smart Fan Technology

The casing alone is a great way to dissipate heat without the need of a fan, but the 2big Network comes with a thermo-regulated "smart fan", which activates when the heat inside the casing reaches a certain temperature. The smart fan operates at two different speeds, and adjusts automatically to changes in temperature.

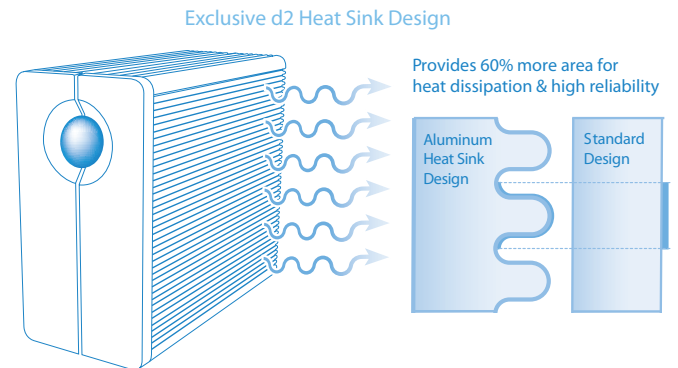

1.4. Views of the 2big Network

Front View

Backup Button with Activity LED (Fig. 01)

The LED remains lit to show that the drive is on.

The blue button on the front of the 2big Network allows you automatically back up an attached external hard drive onto the 2big Network. Simply plug the hard disk into a USB port on the back of the 2big Network and push the button. All data on the attached disk(s) will be automatically copied to the 2big Network.

Rear View (Fig. 02)

1. RAID selection switch
2. off/auto/on power switch
3. USB 2.0 expansion ports
4. Ethernet port
5. Power input connection
6. Drive lock
7. Drive tray handle
8. Left drive status LED
9. Right drive status LED



Fig. 01

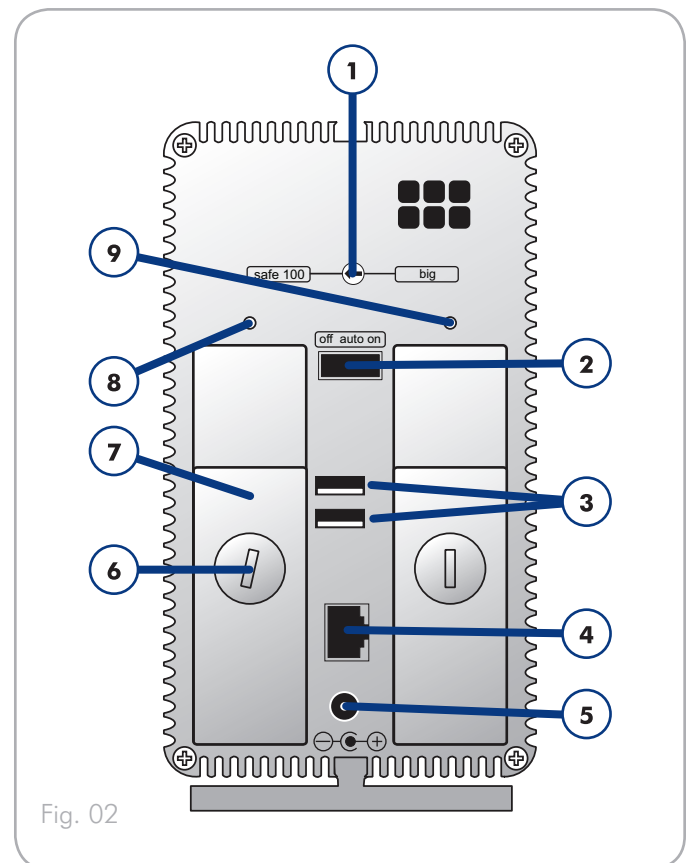

Fig. 02

1.5. Ethernet Cable

Gigabit Ethernet Cables And Connectors

The cables and connectors used to attach Gigabit Ethernet devices are as follows (*Fig. 03 - Ethernet Cable Ends*):



Fig. 03 - Ethernet Cable Ends

TECHNICAL NOTE: LaCie recommends Cat 5E or Cat 6 cables, which support Gigabit Ethernet.

2. Setting Up Your LaCie 2big Network

Follow these steps to power on the LaCie 2big Network and to log on to the administration pages.

Step 1 – [2.1. Turning On the 2big Network](#)

Step 2 – [2.2. Connecting the Ethernet Cable](#)

Step 3 – [2.3. Connecting Using LaCie Network Assistant](#)

2.1. Turning On the 2big Network

The power supply kit is composed of two cables: one cable (A) connects to the LaCie drive; and the other cable (B) connects to a power outlet, such as a wall outlet or a surge protector (Fig. 04).

1. Connect Cable **A** to the 2big Network.
2. Connect Cable **B** to the power supply brick (C).
3. Connect Cable **B** to a surge protector or wall outlet.
4. Turn on the drive by moving the power switch on the back of the drive to the "on" position.

The 2big Network may take up to 60 seconds to boot up.

CAUTION: Only use the AC adapter supplied with your specific LaCie device. Do not use a power supply from another LaCie device or another manufacturer. Using any other power cable or power supply may cause damage to the device and void your warranty.

Always remove the AC adapter before transporting your LaCie drive. Failure to remove the adapter may result in damage to your drive and will void your warranty.

TECHNICAL NOTE: You may use your LaCie drive when in a foreign country thanks to its 100-240 Volt power supply. To be able to use this feature, you may need to purchase an appropriate adapter or cord. LaCie accepts no responsibility for any damage to the drive resulting from the use of an inappropriate adapter. Using an adapter other than one authorized by LaCie will void your warranty.

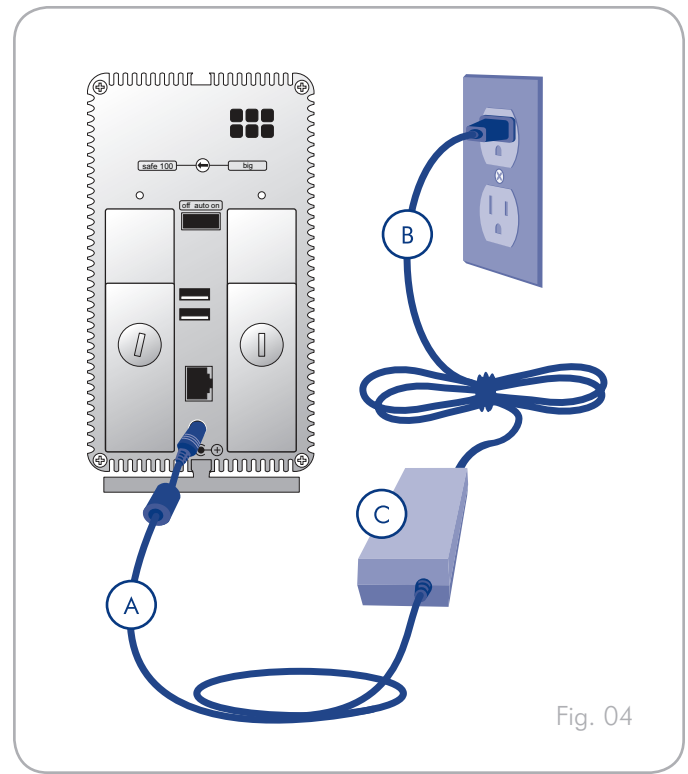

Fig. 04

2.2. Connecting the Ethernet Cable

Unlike regular desktop hard drives, the 2big Network is accessible when attached to your network and does not need to connect directly to your computer (*Fig. 05*).

1. Turn the drive on. See [2.1. Turning On the 2big Network](#).
2. Connect the Ethernet cable to the Ethernet port on the back of the LaCie 2big Network.
3. Connect the other end of the Ethernet cable into an available Ethernet port on your router. Allow a few moments for your network to recognize the drive (**it may take up to 3 minutes on some networks**).

Now move on to step 3, [2.3. Connecting Using LaCie Network Assistant](#).

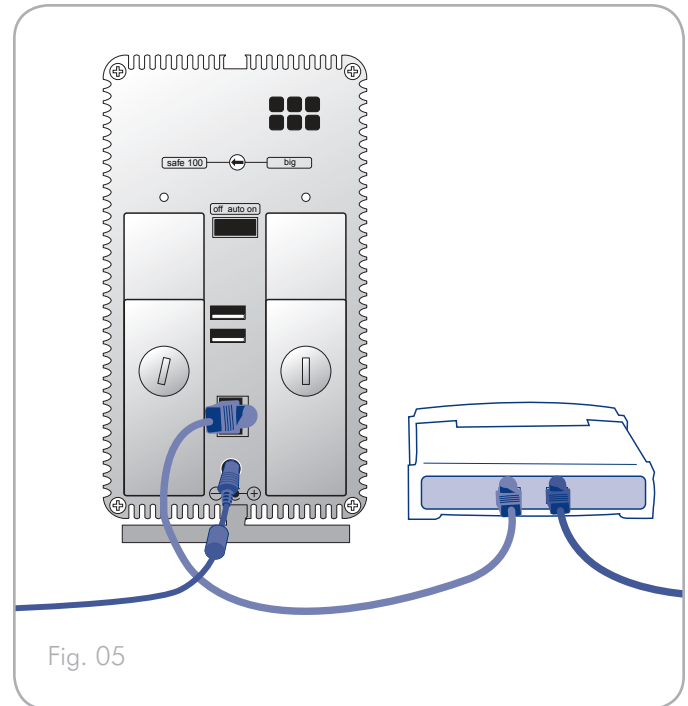

2.3. Connecting Using LaCie Network Assistant

LaCie Network Assistant detects all network attached storage devices on your network and gives you easy ways to connect to or configure them.

Once installed and running, Network Assistant will appear in your task bar (Windows users, [Fig. 07](#)) or in the menu bar (Mac users, [Fig. 08](#)) and automatically search for storage devices on your network. When a new device is found, an info bubble containing the name of the device will appear.

When Network Assistant finds your LaCie 2big Network, you can connect to any of the shares on the 2big Network, log in to the Administration Page, or configure the 2big Network's network settings, all from the Network Assistant menu.

Install LaCie Network Assistant:

1. Insert the LaCie 2big Network CD-ROM into your computer's CD-ROM drive.
2. Windows users, the CD should appear in My Computer. Mac users, the CD should appear on the desktop. Double-click the CD icon, then double-click "LaCie Network Assistant Setup".
3. Follow the Wizard to complete installation.

(continued on next page)



Fig. 06 - LaCie Network Assistant Icon

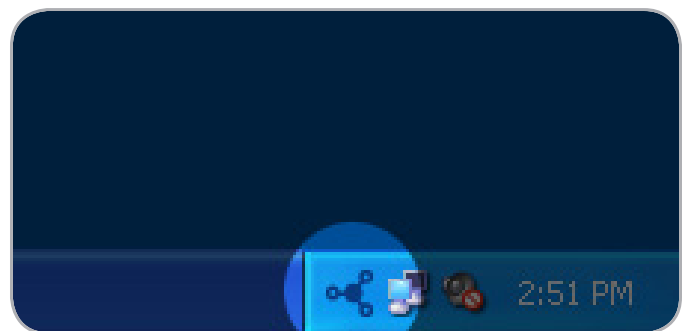

Fig. 07



Fig. 08

Launch the Administration Page

Windows Users

1. Select LaCie Network Assistant in Start/Programs. A Network Assistant icon will appear in the system tray and Network Assistant will automatically detect your LaCie 2big Network and any other LaCie storage devices on your network.
2. Click on the icon in the system tray and select **Configuration Window...** from the LaCie 2big Network sub-menu (Fig. 09). The LaCie Network Assistant page will open.
3. Under the **Network** tab, click the **Web configuration page** link (Fig. 10).
4. To log in to LaCie 2big Network administration (Fig. 11), enter:
Login: **admin**
Password: **admin**

NOTE: This password can be changed from the Administration Page (refer to 4.2. Users).

5. Click **Log on**.

Continue to section 4. *Administering Your LaCie 2big Network*.

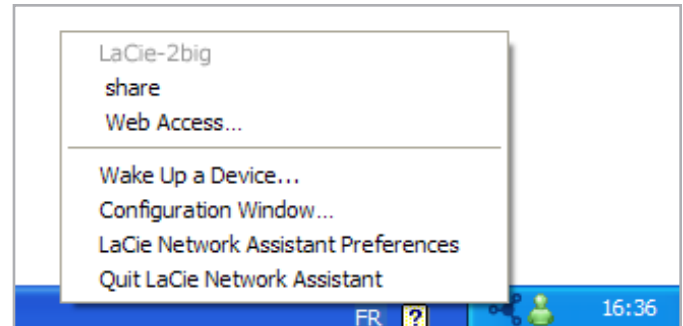

Fig. 09

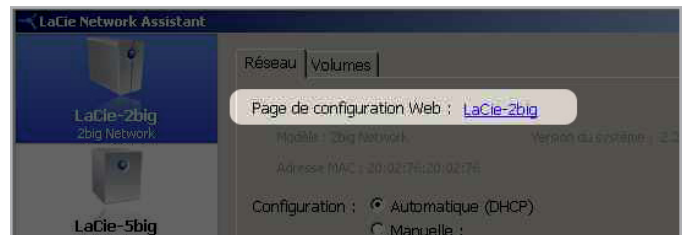

Fig. 10

Mac Users

1. Double click LaCie Network Assistant in your Applications folder. An Network Assistant icon will appear in the menu bar and the Assistant will automatically detect your LaCie 2big Network and any other LaCie storage devices on your network.
2. Click on the icon in the menu bar and select **Configuration Window...** The LaCie Network Assistant page will open.
3. On the Network tab, click the **Web configuration page** link (Fig. 10).
4. To log in to LaCie 2big Network administration (Fig. 11), enter:
Login: **admin**
Password: **admin**

NOTE: This password can be changed from the Administration Page (refer to 4.2. Users).

5. Click **Log on**.

Continue to section 4. *Administering Your LaCie 2big Network*.

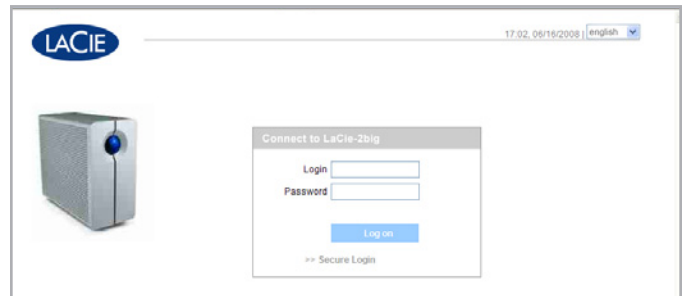

Fig. 11

2.4. Configuring the LaCie 2big Network on a Network Without a DHCP Server

Most home networking routers are DHCP servers, meaning the router assigns an IP address to all devices on the network to allow devices to find each other. If your network does not have a DHCP server, you may need to manually assign your LaCie 2big Network an IP address and other network information.

The easiest way to modify your LaCie 2big Network's network configuration is to use the LaCie Network Assistant. See section 2.3. [Connecting Using LaCie Network Assistant](#) for information on installing the network configuration software.

1. Start LaCie Network Assistant (see section 2.3. [Connecting Using LaCie Network Assistant](#)).
2. **Windows Users:** Click on the LaCie Network Assistant icon in the system tray and select **Configuration Window...** (Fig. 12). The LaCie Network Assistant Configuration window opens (Fig. 13).

Mac users: Click on the LaCie Network Assistant icon in the menu bar and select **Network Configuration...** (Fig. 14). The LaCie Network Assistant Configuration window opens (Fig. 13).

3. Click the **Network** tab.
4. Select **Manual**.

TECHNICAL NOTE: If the fields (IP address, Subnet mask, etc.) are filled when **Automatic (DHCP)** is selected, you do not need to make manual settings. Leave **Automatic** selected.

5. Modify the network settings to work with your network.
 6. Click **Apply**.
-

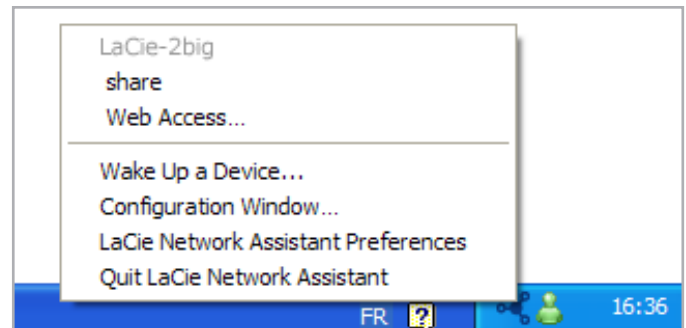

Fig. 12

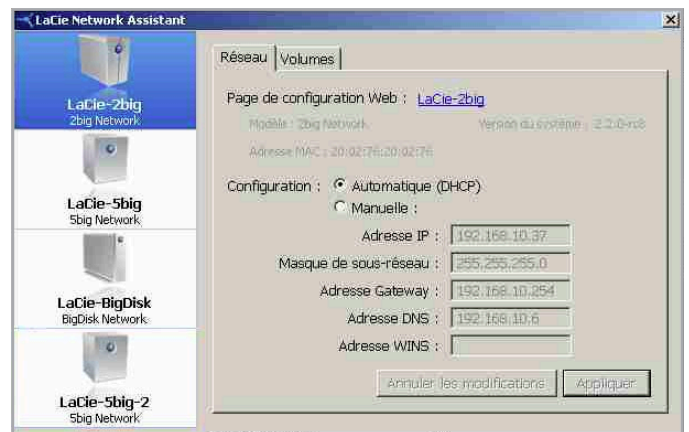

Fig. 13

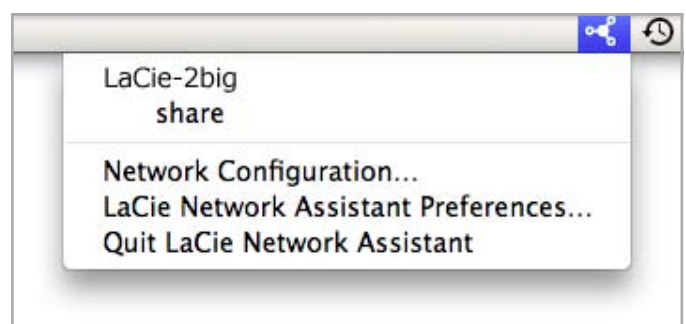

Fig. 14

2.5. Unmounting 2big Network Volumes

To physically turn the 2big Network off, see section [4.5.7.4. Shut Down](#).

Mac Users:

Drag all mounted volume icons to the trash.

Windows Users:

If you have used the LaCie Network Assistant to MOUNT volumes (i.e. if the volume has been assigned a letter in My Computer):

1. Right-click the LNA icon in the task bar and select **Network Configuration...**
2. Select the **Volumes** tab.
3. Right-click a volume and select **Unmount**.

Alternately, if the volumes are not mounted (and so do not appear in My Computer), simply close the Windows Explorer window to disconnect from the volume.

IMPORTANT INFO: After switching off the 2big Network, it takes up to 20 seconds for the operating system to close all services and for all components (LEDs, disks, fan and boards) to power off.

3. Accessing & Managing Files

Use LaCie Network Assistant to access your shared folder(s) (see section 2.3. [Connecting Using LaCie Network Assistant](#)).

You can also connect an external hard drive to use as a backup for your LaCie 2big Network or as additional storage. External drives appear as separate shares and are accessible by anyone on the network. For details, see 3.4. [Connecting External Hard Disks](#).

3.1. Accessing Shared Folders

When your computer is connected to your local area network, LaCie Network Assistant will help you quickly connect to the shared folder(s) on your LaCie 2big Network.

To access shared folders (all users):

1. Run the LaCie Network Assistant (LNA). Click on the LNA icon in the system tray (Windows users, [Fig. 15](#)) or menu bar (Mac users, [Fig. 16](#)).
2. Select **Share** (default) or the name of any other share you have created from the LNA menu. The share will open in a Windows Explorer or Mac Finder window.

TECHNICAL NOTE: You may need to enter the username and password for “share.” The defaults are:

Username: admin

Password: admin

Your system may remember this information and might not ask for it during the same session.

See section 4.2.6. [Editing User Accounts](#) for information on changing the User account information.

3. Simply drag and drop files to and from this window, just like a regular folder.
-

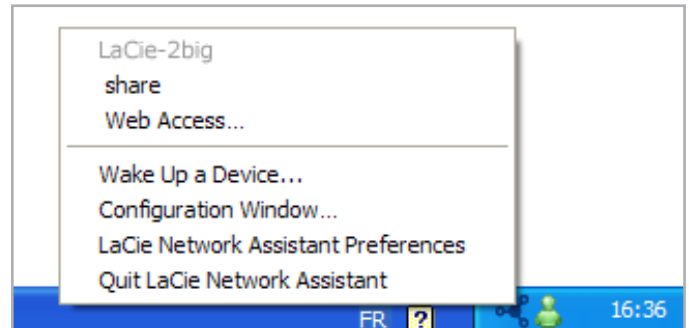

Fig. 15

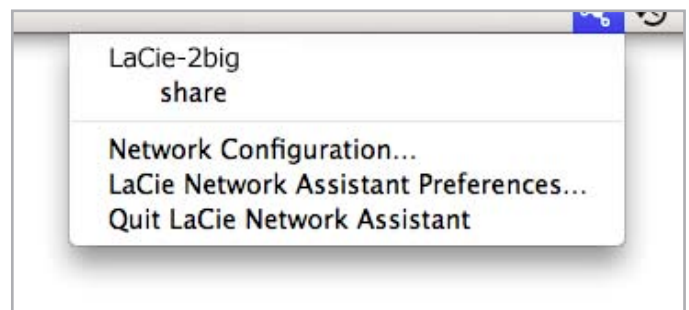

Fig. 16

3.1.1. Other Connection Methods

Vista/XP/2000 Users – My Network Places

IMPORTANT INFO: If you have just turned on the LaCie 2big Network, it may take a few moments for it to appear on the network.

To access the share in Windows, look in My Network Places, and select **Microsoft Windows Workgroup**. By default, the 2big Network will be named **LaCie 2big Network (Lacie-2big Network)** (Fig. 17).

Alternatively, you can access the share by typing the following in a Windows explorer address field (Fig. 18.):

\\LaCie-2big\[share name]

\\[IP address]\[share name] Find the IP address by running the LaCie Network Assistant (section 2.3. [Connecting Using LaCie Network Assistant](#)).

For FTP access, type:

ftp://LaCie-2big or ftp://[IP address]

In the logon window that opens, type:

Login: **admin**

Password: **admin**

(This user name and password is the factory default; if you have already created a user, input your user name and password.)

The LaCie 2big Network will appear as a drive with one share folder on the network.

Windows Me/2000

For Windows Me and Windows 2000 users, if you cannot find the LaCie 2big Network from your workstation, try using the Windows search tool.

From the Start menu, select **Search**, and then click on **For Files or Folders**. In the **Search Results** window, select **Computers**.

In the **Search for Computers** dialog box, enter the server name and click the **Search Now** button. By default, the LaCie 2big Network will be named "LaCie-2big", and the share "SHARE".

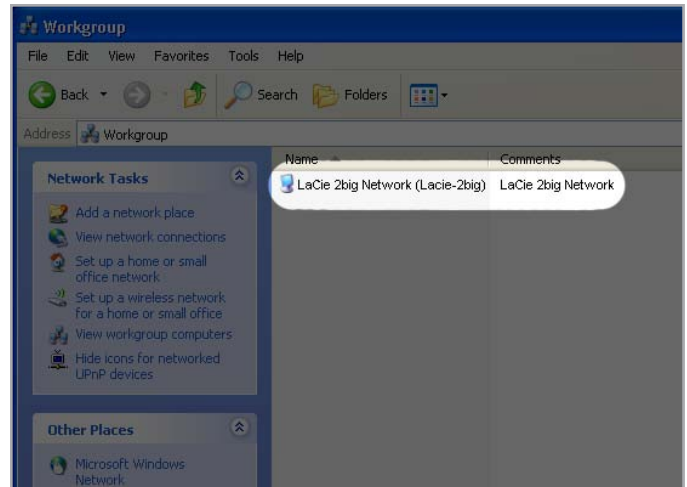

Fig. 17

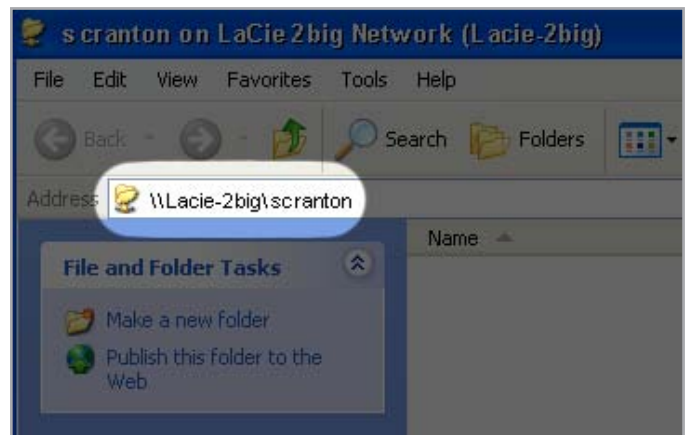

Fig. 18

Mac OS 9.x Users

From the Apple menu, select **Network Browser**, **Chooser** or **Connect to Server**. In Chooser, click the **Appleshare** icon. Your server should appear in the list with the default name "LaCie-2big". Select it and press **OK**.

Linux Users

Under KDE, open konqueror and type in the IP address of the LaCie 2big Network into the address field:

For FTP access – **ftp:// [IP address]**

For HTTP access – **http:// [IP address]**

For SMB/CIFS access (in order for this to method to work, the services need to be properly configured) – **smb:// [IP address]**.

3.2. FTP Access to Shares

The FTP protocol is used to transfer files from one computer to another through a network, such as over the internet. This protocol allows you to exchange files with your friends or relatives securely, as only people to whom you have provided the user name and password will have access. FTP access also provides you a way to access your files remotely.

In order to make your 2big Network accessible via the internet, configure your router to allow remote connections using FTP. This process varies depending on the router.

For the 2big Network to be accessible through the internet, port 21 needs to be forwarded to the 2big Network.

TECHNICAL NOTE: By default, FTP is enabled and therefore Share is fully accessible via FTP. To turn FTP service off, refer to section [4.5.6. Status](#).

3.3. Administration Page – Browse

To access files from the Administration page, just log in. Regular users will have direct access to the shares on the 2big Network, with no access to administrative features. The administrator can click on **Browse** in the navigation bar to access files stored on the 2big Network. The administrator will have access to all files. Other users will only have access to the files to which the administrator has given them access.

All shares are listed on the left side of the page (Fig. 19). To see the files in a share, click on the share name (Fig. 20).

Administrators, to return to 2big Network administration, click the **Administration** button. This is not available to non-administrators.

3.3.1. Uploading Files

To upload a file to a share:

1. Click on the share (folder) you want to upload the file to.
2. Click **Upload file**.
3. Click **Browse...** a file browser opens. Select the file to upload.
4. Click **Apply**.

TECHNICAL NOTE: If the file does not appear in the folder after the upload process is complete, just click on the folder name again to refresh the view of the folder contents.

IMPORTANT INFO: Uploads are limited to 55MB.

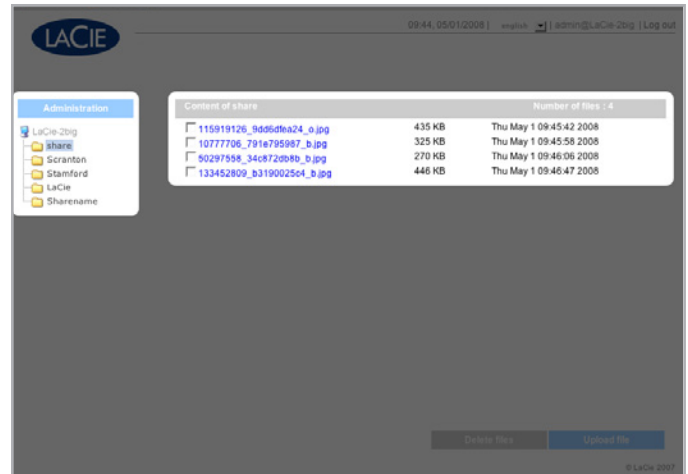

Fig. 19

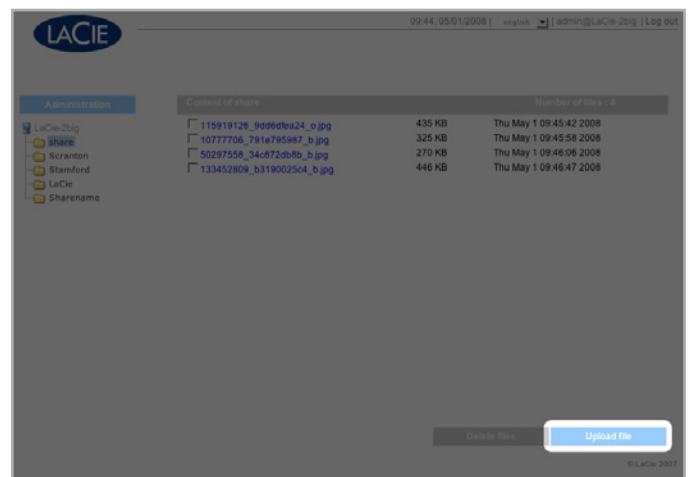

Fig. 20

3.3.2. Downloading Files

To download a file:

1. Click on the share (folder) you want to download the file from.
2. Click on the file's link (Fig. 21).
3. **Internet Explorer**: in the security warning window, click to allow the download. File saves to the default downloads directory.
4. **Firefox** and **Safari**: File downloads to the default downloads directory.

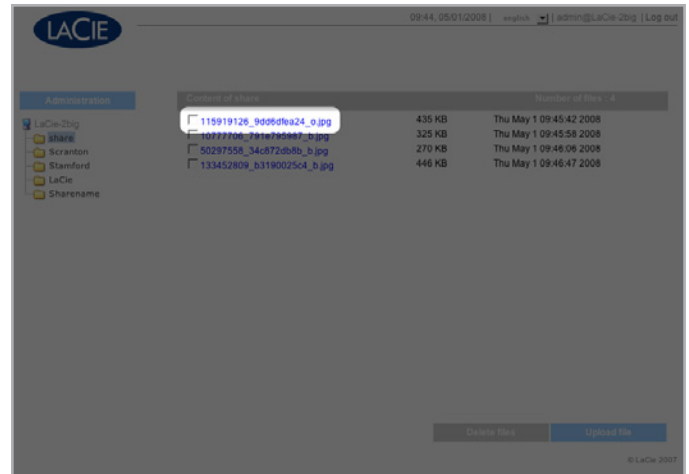

Fig. 21

3.3.3. Deleting Files

To delete a file from a share:

1. Click on the share (folder) you want to delete the file from.
2. Select the file or files to delete.
3. Click **Delete files** (Fig. 22).
4. Click **OK** on the confirmation dialog.

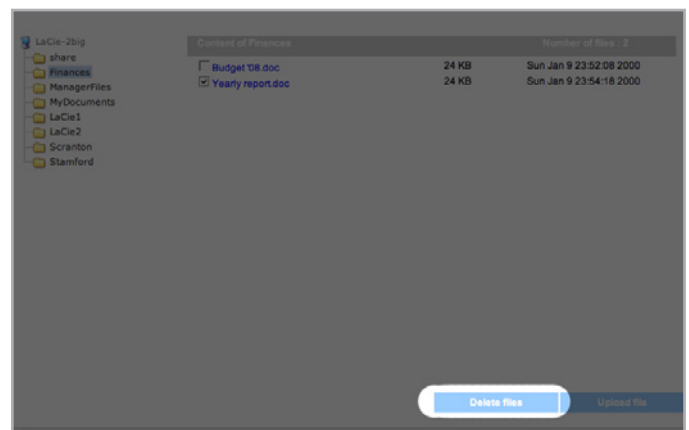

Fig. 22

3.3.4. Logging Out

Log out at any time by clicking **Log out** in the upper right corner of the Administration Page (Fig. 23).

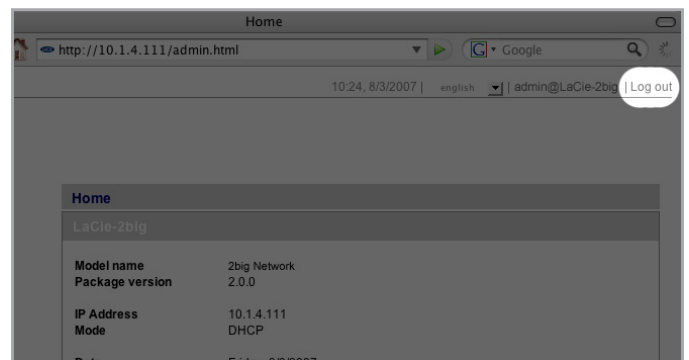

Fig. 23

3.4. Connecting External Hard Disks

You can connect an external USB hard disk to back up the data on your LaCie 2big Network or as a way to add storage capacity. Connected hard disks are accessed similarly to shared folders.

TECHNICAL NOTE: External hard disks must be formatted in one of the supported systems in to mount on the LaCie 2big Network: FAT32, NTFS, HFS+, EXT3, REISERFS or XFS.

In order to use an external hard drive to back up the d2 Network, the drive must be formatted in one of the file formats listed above, with the exception of NTFS. NTFS volumes cannot be used to back up the 2big Network because this file system format is read-only when connected to the 2big Network. External drives can be formatted to XFS through the Web administration page. For details, see [4.5.5. Disks](#).

To connect an external hard disk:

1. Turn on your LaCie 2big Network.
2. Turn on the external hard disk (if it has a power button) and connect its USB cable to the USB port on the back of the LaCie 2big Network ([Fig. 24](#)).
3. In the Web Administration Page, click **System** and then on the **External Disks** tab.

The external hard drive will be listed ([Fig. 25](#)). For more information, see [4.5.5. Disks](#).

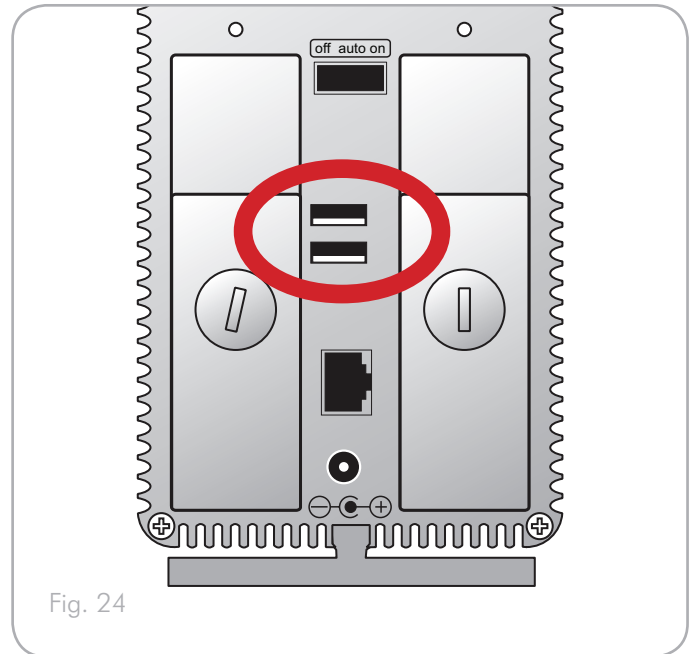

Fig. 24

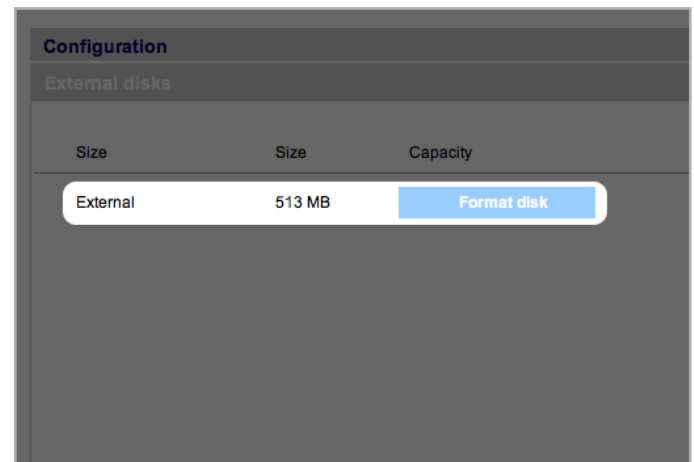

Fig. 25

4. Administering Your LaCie 2big Network

The LaCie 2big Network features an easy-to-use Web-based tool for configuring the drive and administering users, referred to here as the Administration Page.

Accessing the Administration Page is easy, whether you're using a browser (all users) or the LaCie Network Assistant (LNA).

When you log in as "admin", you will see a series of blue navigation links on the left side of the page (Fig. 26) to help you navigate and configure the LaCie 2big Network:

- ◆ Section 4.2. *Users*: Add, delete or edit users, including assignment of folder access privileges.
- ◆ Section 4.3. *Groups*: Add, delete or edit groups, add users to groups, assign group access privileges
- ◆ Section 4.4. *Shares*: Create, delete or edit shares, change access restrictions
- ◆ Section 4.5. *System*: Change system settings, manage disks and RAID settings, manage system updates
- ◆ Section 4.6. *Download*: Configure your LaCie 2big Network to be a torrent server.
- ◆ Section 4.7. *Backup*: Back up your LaCie 2big Network onto an external USB hard drive
- ◆ Section 4.8. *Browse*: Access files and folders, upload and download files, delete files
- ◆ Section 4.9. *Import (Snapshot)*: Click the front button to automatically import the data on an attached external hard drive
- ◆ Section 4.10. *Multimedia*: Set up your d2 Network as a multimedia server, providing access to its files to compliant digital media devices

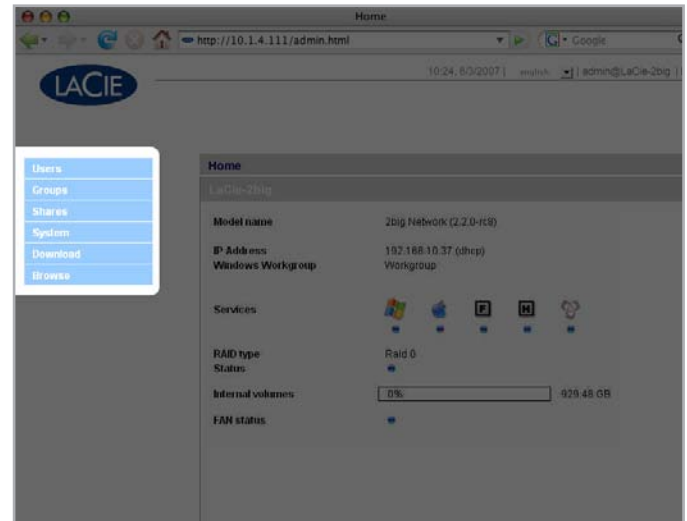

Fig. 26

4.1. Accessing the Administration Page

NOTE: The easiest way to access the Administration Page is to use LaCie Network Assistant (see section 2.3. [Connecting Using LaCie Network Assistant](#)).

To access the Administration Page with a browser:

In your browser's URL (web address) field, type one of the following:

Mac users: <http://lacie-2big.local>. (Fig. 27)

PC users: <http://lacie-2big> (Fig. 27)

or

<http://IP address> (Fig. 28)

Find the IP address by running the LaCie Network Assistant (section 2.3. [Connecting Using LaCie Network Assistant](#)).

TECHNICAL NOTE: The IP address of your LaCie 2big Network may be different than the IP address shown in Fig. 28.

On the login page (Fig. 29), type:

Login: **admin**

Password: **admin**

IMPORTANT INFO: The login name and password are both set to "admin" by default. The admin password can be changed, but not the login name. See section 4.2. [Users](#) for more information.

If you are logged in as "admin", the Administration Page will open. For non-admin users the file browsing page will open.

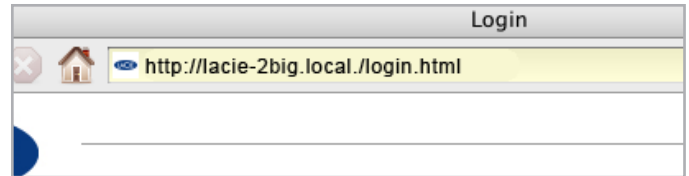

Fig. 27

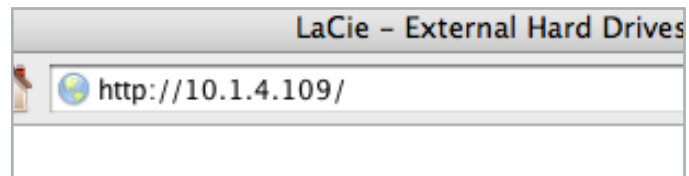

Fig. 28

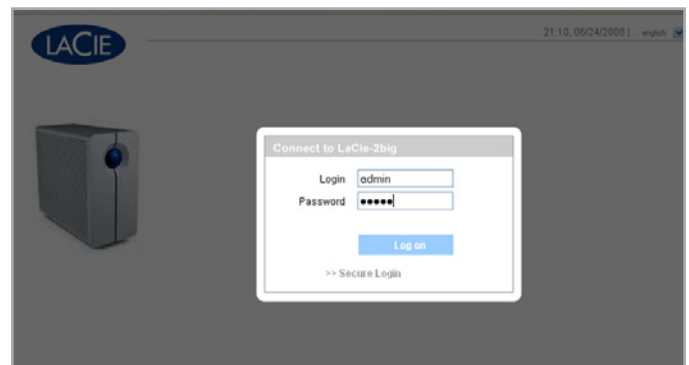

Fig. 29

4.1.1. Setting the Display Language

The default display language is set to your browser's language. If your browser's display language is not supported, 2big Network administration will default to English. You can change the display language at any time by selecting a language from the menu in the upper right corner of the administration page (Fig. 30). This can be done from the Log On page, as shown, so you can proceed from the beginning in your own language.

English	Français	Deutsch
Italiano	Español	Dutch
Svenska	Dansk	Japanese

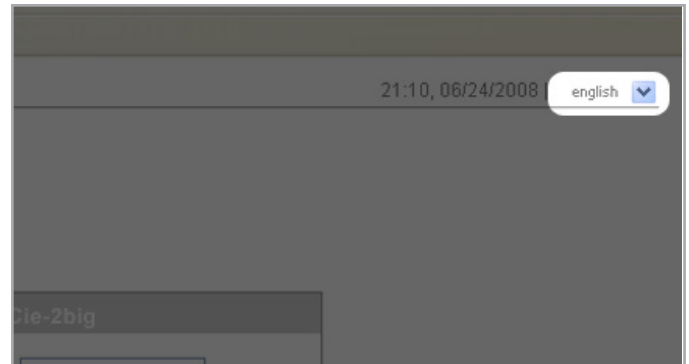

Fig. 30

4.1.2. Administration Home Page

When you log into LaCie 2big Network administration, the Home page opens (Fig. 31). This page contains information about the status of the 2big Network.

The **Fan Status** indicator (a) will be in one of three states:

- ◆ Blue – the fan is on and working.
- ◆ Gray – the fan is off.
- ◆ Red – the fan has failed. The 2big Network will continue to function with a failed fan, but overall system reliability is impacted. Contact your LaCie reseller or LaCie customer support in the event of a fan failure. See section 8.1. *LaCie Technical Support Contacts*.

The **RAID Status** indicator (b) will be in one of three states:

- ◆ Blue – the disks are on and working.
- ◆ Gray – disks are functional, but not accessible (for example, data is being rebuilt).
- ◆ Red – RAID not functional. Check the Disk page (**System > RAID**) for error messages.

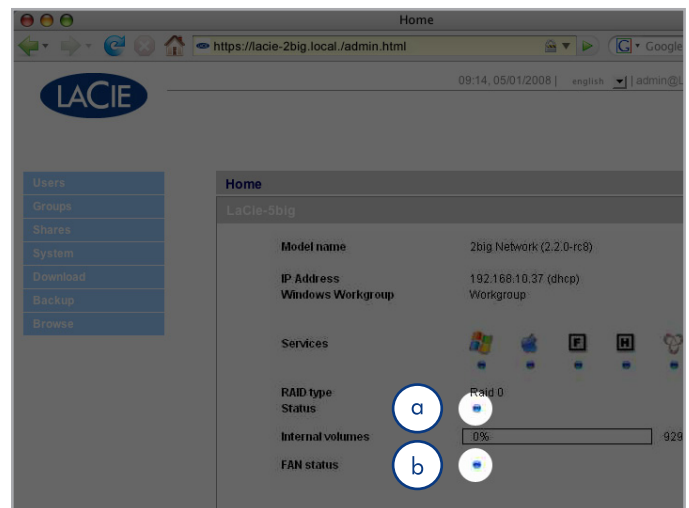

Fig. 31

4.2. Users

Click on the **Users** link in the navigation bar to open the User Accounts page. Use this page to create, edit and delete user accounts.

Administrator Account

Only one user can have administrative privileges for the 2big Network. This user's login name cannot be changed from "admin", but the password can be changed.

IMPORTANT INFO: The admin user can also enter an email address to which the 2big Network can send messages about important changes to the 2big Network's status (see below).

To change the administrator's password:

1. Click on the "admin" user in the user list on the Users page. The "User profile Admin" page opens (a, [Fig. 32](#)).
2. Enter a new password in the "Password" field. Enter the password again in the "Confirm password" field.
3. Click **Apply** (b, [Fig. 33](#)).

Email Notifications

The administrator can provide an email address to which the 2big Network will send notifications of important status changes, such as disk failure (see chart in section 7. [Email Notification Triggers](#)).

TECHNICAL NOTE: The 2big Network has an integrated SMTP server that sends emails through port 25. This service is thus disabled if port 25 is blocked (as with Livebox, Orange, and France Telecom). As many ISPs block this port, you must configure your router to authorize traffic through this port in order for this service to work.

[Fig. 33](#) shows an email sent informing the administrator that the 2big Network's temperature has reached critical levels and will be automatically shutting down.

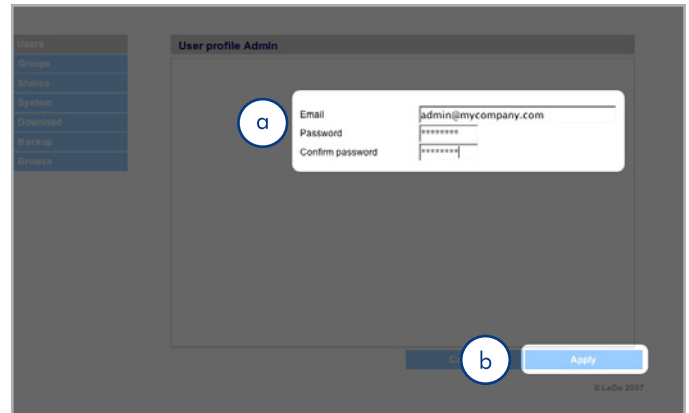

Fig. 32

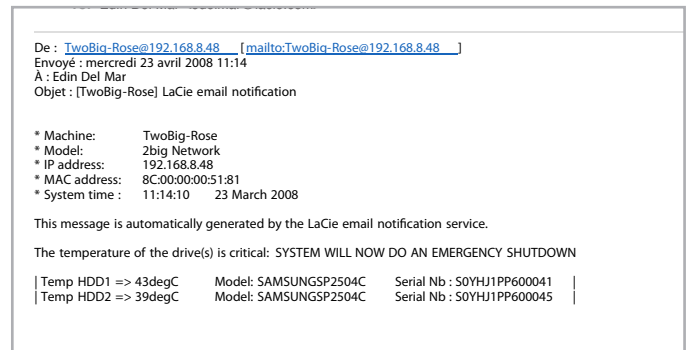

Fig. 33

4.2.1. Adding Users

To add a user account:

1. Click **Add** on the User Accounts page (Fig. 34). The User Profile page opens (Fig. 35).
2. Enter a login name in the "Login" field.

IMPORTANT INFO: Login names are case-sensitive. (Ex. "User" is not the same as "user".)

3. Enter the user's first and last name in the First name and Last name fields. This information only appears to the administrator as part of the User Profile on this page.
4. Check Password to require the user to log in with a password. If the Password box is unchecked, the user can log in with a Login name only.
5. Enter a password in the "Password" and "Confirm password" fields, if applicable.

TECHNICAL NOTE: Passwords cannot exceed 8 characters.

6. To enable the user account (allow the user to log in), select **Enabled** from the **Status** menu.
 7. Click the **Apply** button.
-

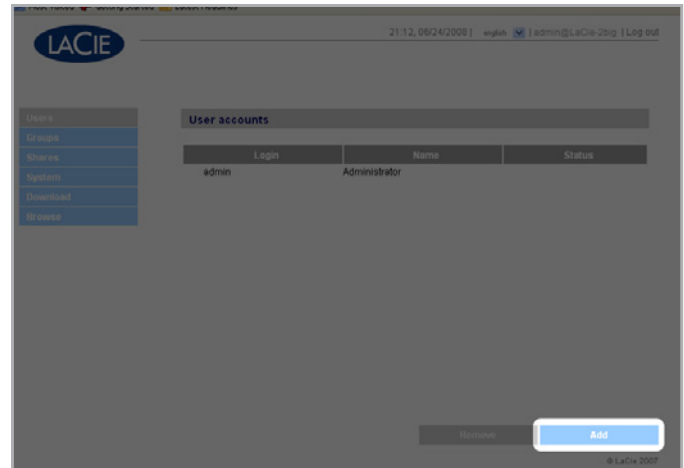

Fig. 34

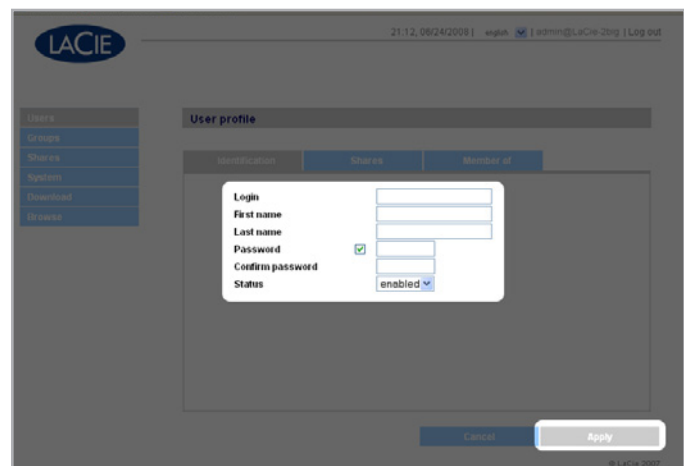

Fig. 35

4.2.2. Setting User Access to Shares

All of the shares on your 2big Network are listed on the **Shares** tab of each user's profile page. Shares have three access levels:

- ◆ **Read & Write** – users with Read & Write access can upload, download and save files
- ◆ **Read Only** – users with Read only access can download and view files but cannot upload files
- ◆ **No Access**

See section 4.2.4. *About Access Privileges* for more information.

To set user access to shares:

1. Click the **Shares** tab on the user's **User Profile** page.
2. Select **Read & Write**, **Read Only** or **No Access** for each share (Fig. 36). No Access is selected by default.

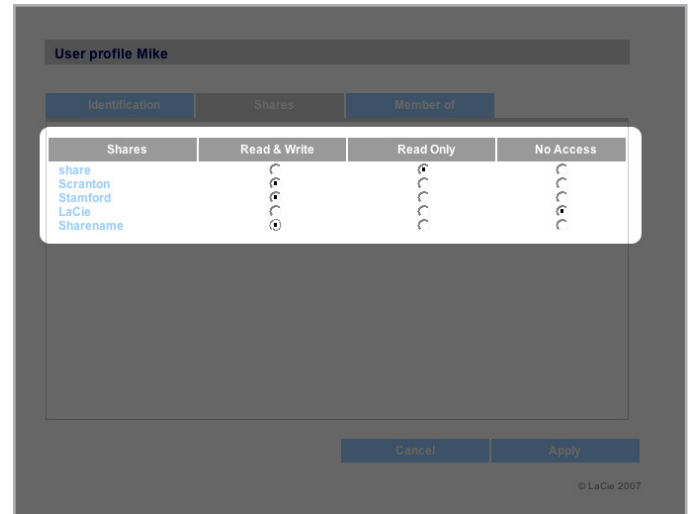

Fig. 36

4.2.3. Setting Group Membership

All of the groups on your 2big Network are listed on the **Member of** tab of each user's profile page. Users can belong to an unlimited number of groups.

See section 4.2.4. *About Access Privileges* for more information.

To set user group membership:

1. Click the **Member of** tab on the user's User Profile page.
2. Check the box for each group to which you want to assign the user (a, Fig. 37).

IMPORTANT INFO: When you are done configuring the new user click **Apply** to save your settings for the new user and to add the user to the users list (b, Fig. 37).

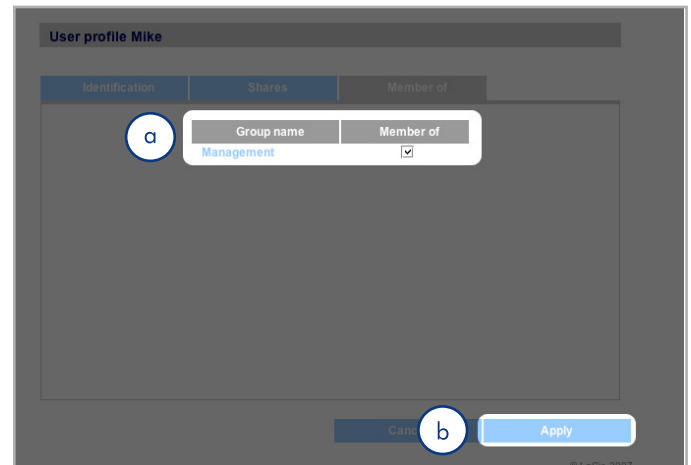

Fig. 37

4.2.4. About Access Privileges

Access privileges can be assigned to users on an individual user basis or on a group basis. User-level access is more restrictive.

Here is an example of the way access privileges work when a user has different kinds of access to the same share as member of a group and as an individual:

- ◆ User U belongs to groups G1 and G2, and has access to share S.
- ◆ If G1 has read-only access to S and G2 has read-write access to S, then U will have read-write access to S.
- ◆ If U has read-only access to S and G2 has read-write access to S, then U will have **read-only** access.

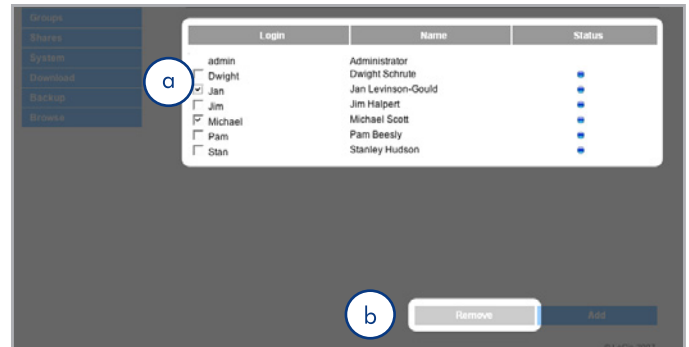

Fig. 38

4.2.5. Deleting User Accounts

On the User Accounts page (Fig. 38), check the box beside each user you want to delete (a) and click **Remove** (b).

4.2.6. Editing User Accounts

The administrator can edit the details of a user account at any time by clicking on a user on the User Accounts page to view the user's profile (Fig. 39).

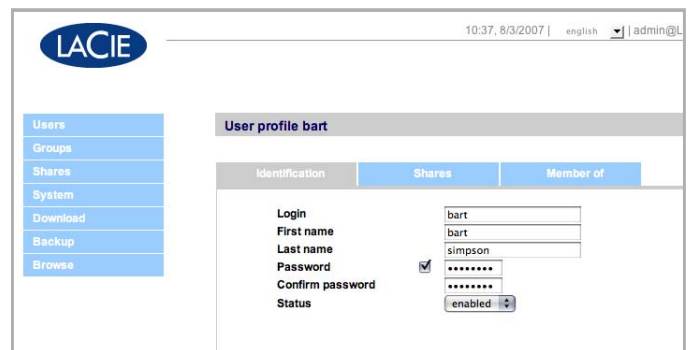

Fig. 39

4.3. Groups

Click on the **Groups** link in the navigation bar to open the Groups page (Fig. 40). Use this page to create, edit and delete groups.

If you use your 2big Network in an office setting where many different people from different departments need to have access to the 2big Network, setting up groups is a good way to organize users and to give the most appropriate access to shares. You can specify which shares groups can access, which users belong to which groups and enable or disable entire groups.

4.3.1. Adding Groups

To add a group:

1. Click **Add** on the Groups page (Fig. 41). The Group Profile page opens (Fig. 42).
2. Enter a name and description for the group. The description only appears to the administrator as part of the Group Profile on this page (a, Fig. 42).
3. Select “enabled” to activate the group as soon as your changes are applied.
4. All user accounts on the 2big Network are listed in the User column. Select the users you want to be in the group.
5. Click **Apply** (b, Fig. 42).

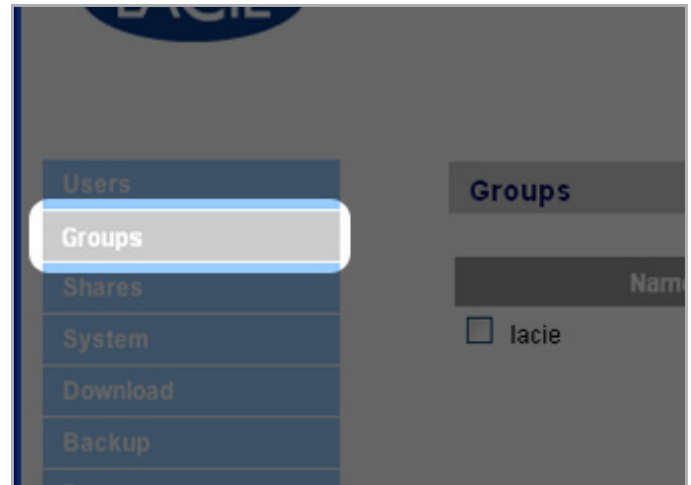

Fig. 40

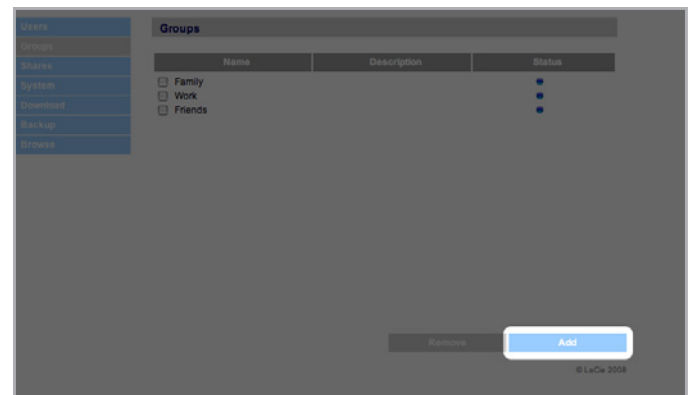

Fig. 41

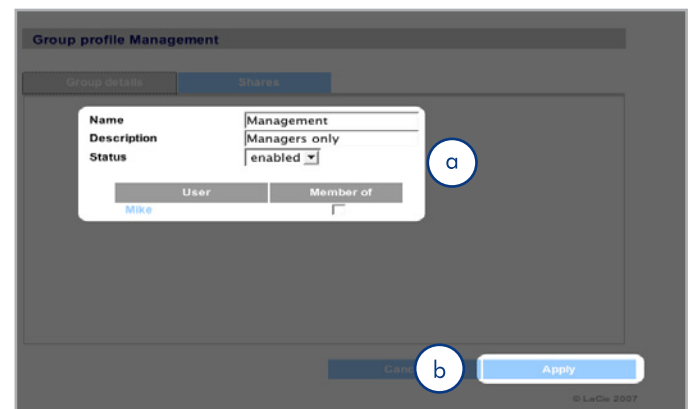

Fig. 42

4.3.2. Setting Group Access to Shares

All of the shares on your 2big Network are listed on the **Shares** tab of each group's profile page. Shares have three access levels:

- ◆ **Read & Write** – groups with Read & Write access can upload, download and save files
- ◆ **Read Only** – groups with Read only access can download and open files but cannot save files
- ◆ **No Access**

See section 4.2.4. *About Access Privileges* for more information.

To set group access to shares (Fig. 43):

1. Click the **Shares** tab on the group's Group Profile page (a).
2. Select **Read & Write**, **Read Only** or **No Access** for each share (b). No Access is selected by default.
3. Click **Apply** (c).

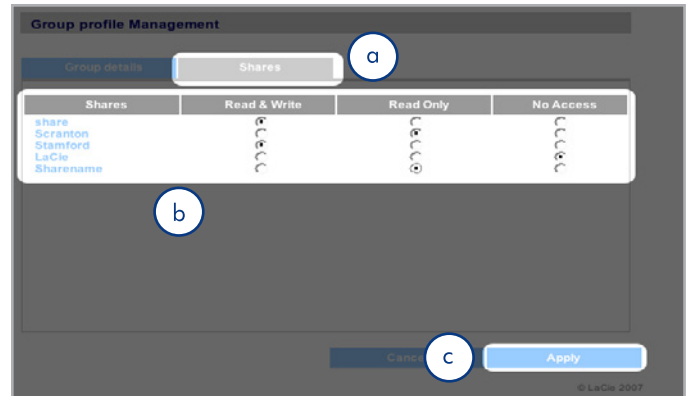

Fig. 43

4.3.3. Deleting Groups

On the Groups page, check the box beside each group you want to delete (a) and click **Remove** (b) (Fig. 44).

IMPORTANT INFO: Deleting a group does not delete the users within the group. Go to the Users page to delete user accounts.

4.3.4. Editing Groups

The administrator can edit the details of a group's profile at any time by clicking on a group on the Groups page to view the group's profile.

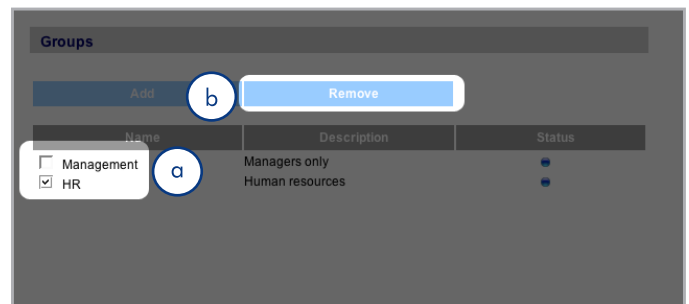

Fig. 44

4.4. Shares

Click on the **Shares** link in the navigation bar to open the Shares page (Fig. 45). Use this page to create, edit and delete shares.

4.4.1. Creating Shares

To create a share:

1. Click **Add** on the Shares page. The Share Details page opens (Fig. 46).
2. Enter a name and description for the share (a). The description only appears to the administrator as part of the Share Profile on this page.

TECHNICAL NOTE: The share name cannot contain any of the following characters: \ / [] : | < > + = ; , ? * @ and space.

3. Select **Enabled** from the Status menu to make the share accessible. Select **Disabled** to create the share but make it inaccessible (b).
4. To make the share accessible in read/write mode to anyone, unclick the "Allow public read access" check box and click "Allow public read and write access" (c). No password is needed to access the share. Select "Allow public read access" to require a password for read/write access. Anyone can access an "Allow public read access" share in read-only mode.
5. Select the protocols which will be used to access the share. You can choose from Windows (SMB), Apple (AFP), FTP or HTTP (d). Click the **Apple Time Machine compatible** button to allow this share to be used as a target volume for backup using Time Machine.
6. Click **Apply** (b).



Fig. 45

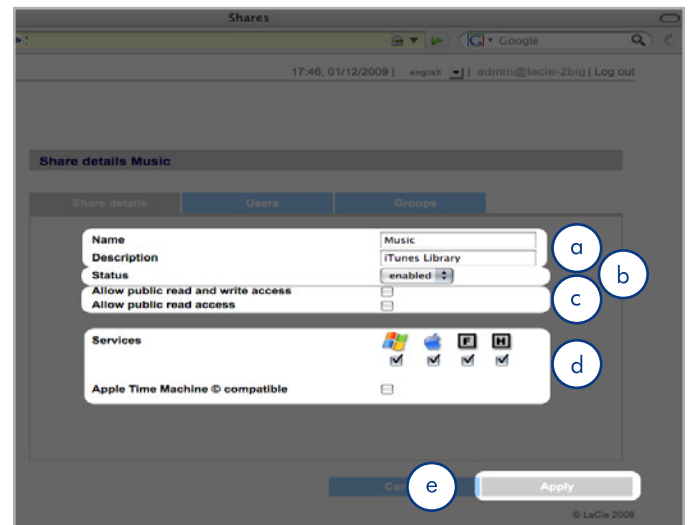

Fig. 46

4.4.2. Deleting Shares

On the Shares page (Fig. 47), check the box beside each share you want to delete (a) and click **Remove** (b). Deletion of the share could take just a few seconds to several minutes, depending on the size of the share.

CAUTION: Deleting a share deletes all files contained within the share folder. Back up any data you want to save before deleting a share.

4.4.3. Editing Shares

The administrator can edit the details of a group's profile at any time by clicking on a group on the Groups page to view the group's profile (Fig. 48).



Fig. 47

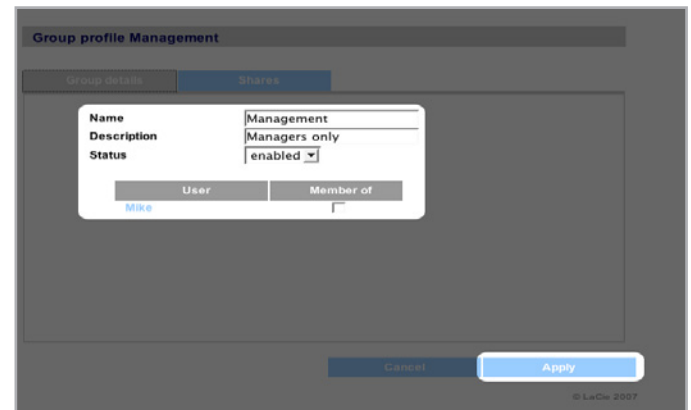

Fig. 48

4.5. System

In addition to the Configuration page, which is the main System page, the System menu has four sub-sections: Network, Disk, Status and Maintenance, each accessible from the navigation bar when you click **System**.

4.5.1. Active Directory

The 2big Network can join a Microsoft Active Directory. Active Directory is the directory service that is included with Microsoft Windows Server 2003 and Microsoft Windows 2000 Server. By creating a link between user accounts, mailbox accounts, and applications, Active Directory simplifies the task of adding, modifying, and deleting user accounts. Integrating the 2big Network with your Active Directory allows the 2big Network to streamline the creation of users, groups, and access privileges.

To connect, click on **System > Join Domain**. Enter a domain name, username, and password and click **Join Domain** (Fig. 49).

Once the 2big is connected to the domain, the administrator will be able to add users or groups in the following way:

TECHNICAL NOTE: In order to assign access to a share to a user(s) or group(s), the "Allow public read and write access" button must be unchecked.

1. Navigate to the **Shares** page.
2. Click on the share to which you wish to add users.
3. In the search field, add a user by one of the following methods:
 - a. Type the name and click **Add**.
 - b. Typing a few characters of the username and click **Search** (Fig. 50). In the list of found users, simply click the user.

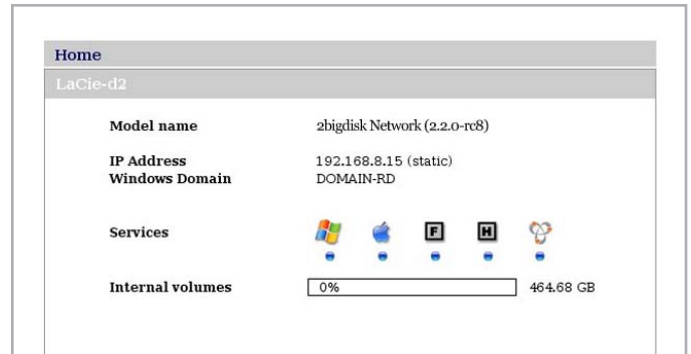

Fig. 49

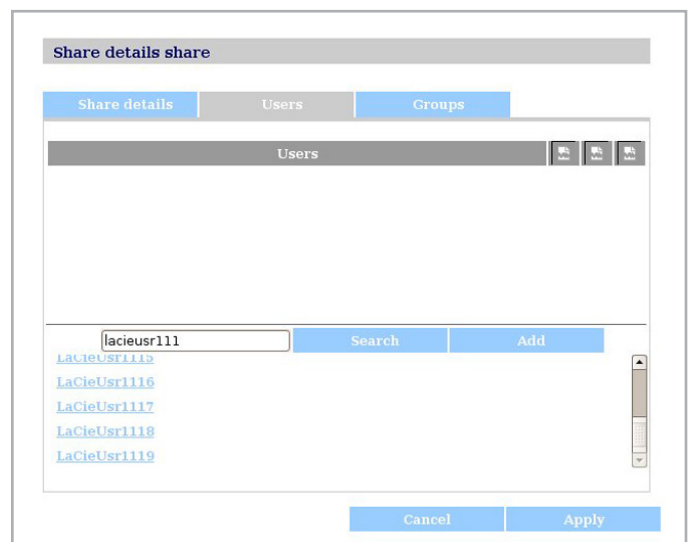

Fig. 50

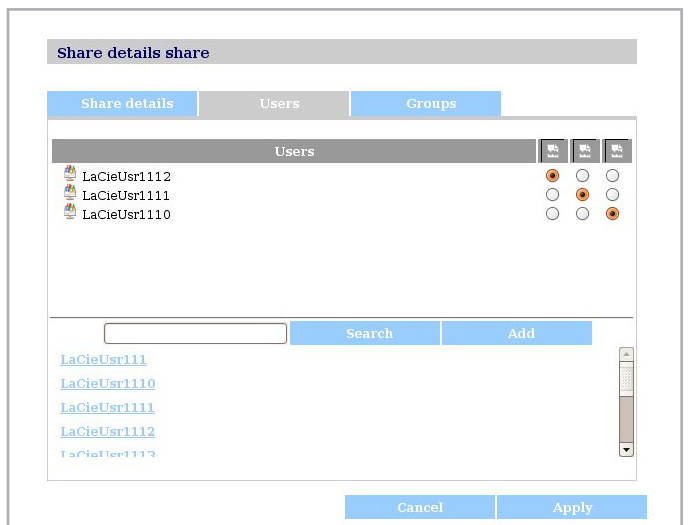

Fig. 51

4.5.2. Configuration

Click on the **System** link in the navigation bar to open the Configuration page. This page displays basic information about the 2big Network including the Machine name, the Windows workgroup, time zone and date and time (a, Fig. 52).

To change the machine name, highlight the machine name (“LaCie-2big Network” by default), delete it and enter a new name. Click **Apply** (b, Fig. 52)

IMPORTANT INFO: The machine name can only contain the following characters ‘a-z’, ‘A-Z’, ‘0-9’, ‘-’ and must begin with a letter.

To change the Windows workgroup, highlight the workgroup name, delete it and enter a new name. Click **Apply** (b, Fig. 52).

Click the **Enable the front blue light** checkbox to toggle the light on or off.

To change the time zone, click on the current time zone location to activate the time zone drop-down menu (a, Fig. 53) and select a location in your time zone. Click **Apply** (b, Fig. 53).

TECHNICAL NOTE: The 2big Network has a 30-minute time-out cycle.

To change the date and time, select a time zone and click the **Synchronize with PC** button. The date and time will automatically synchronize with your computer. Click **Apply** (b, Fig. 53).

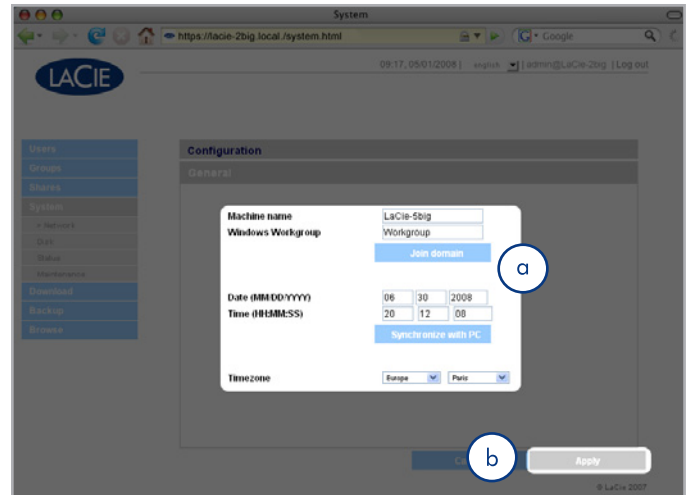

Fig. 52

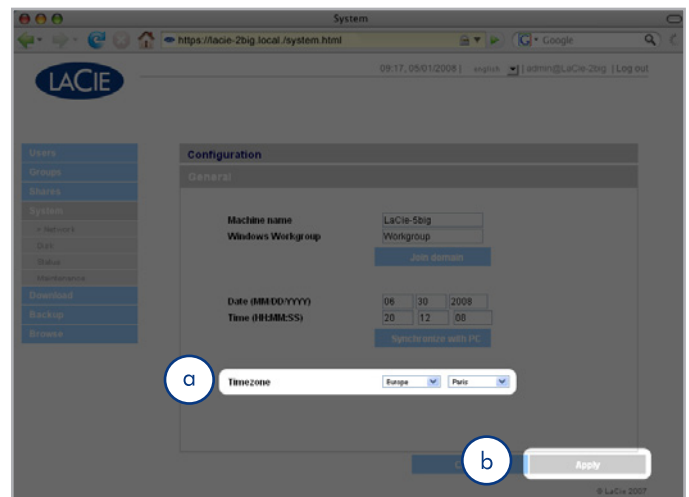

Fig. 53

4.5.3. Network

The Network page allows you to choose how the IP address of the 2big Network is obtained, either automatically from a DHCP server on your Network, or manually with settings that you input.

4.5.3.1. Obtain IP from DHCP Server

If your 2big Network is connected to a network with a DHCP server, simply check the “Automatic IP from DHCP server” box (Fig. 54). Your DHCP server will assign an IP address to the 2big Network every time it connects to your network.

4.5.3.2. Configure IP Manually

This method is used when the LaCie 2big Network is connected to a non-DHCP enabled network or if you have elected to manually configure your IP (Fig. 55). In this case, you will need to manually assign the correct network settings for your LaCie 2big Network. Please check with your network administrator for more information about your network and which parameters you should use. For more information, see section 2.4. *Configuring the LaCie 2big Network on a Network Without a DHCP Server.*

IMPORTANT INFO: If the DHCP server’s automatic IP address configuration function is selected/activated and there is no DHCP server on the network, the 2big Network will check first the DHCP, then the APIPA. If no address is found, an address ranging from 169.254.1.1 to 169.254.254.254 will be assigned.

IMPORTANT INFO: The 2big Network supports frame (i.e. packets) sizes larger than 1500 bytes on the Gigabit Ethernet interface (Fig. 56). JumboFrame capability extends supported frame size to 9000 bytes (9KB). In general, the higher the frame size, the better the network performance. Do not modify the JumboFrame size if your network is not configured for JumboFrame functionality. Check with your network administrator.

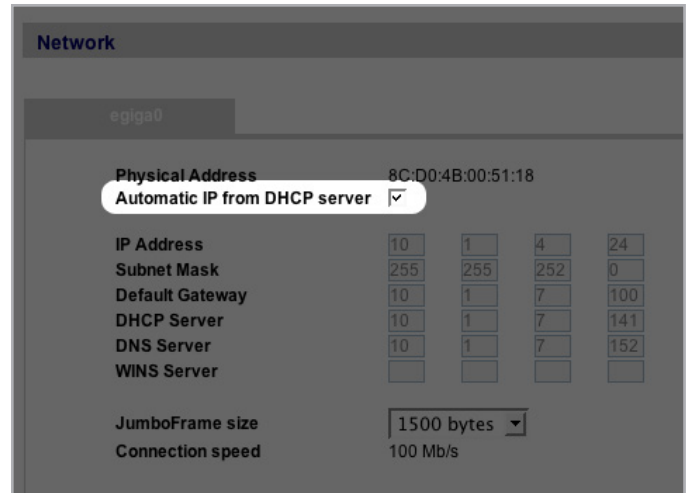

Fig. 54

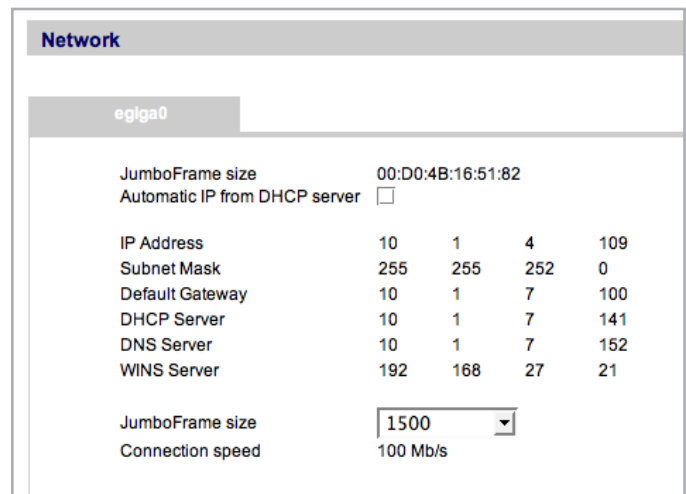

Fig. 55

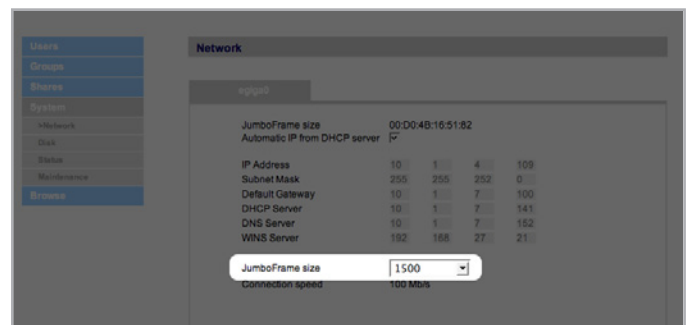

Fig. 56

4.5.4. RAID

Changing the RAID mode

Changing the RAID mode involves two main steps, changing a physical setting and confirming the setting on the Administration Page.

CAUTION : Changing the RAID mode destroys all data stored on the LaCie 2big. If you have saved data on the drives, back up data before following these steps.

To change the RAID mode:

1. Insert the 2-in-1 tool into the groove on the rotary switch and turn the tool to the left or right to select a different mode.
2. Sign in to the Administration page administrator account.
3. Click on **System > RAID** (Fig. 57).
4. Select the **Format** button (a, Fig. 57).
5. The 2big will create a new RAID array and erase all data from the disks. The front LED will blink blue for 2.5s and pause for 0.5s until the RAID mode has fully changed. During the rebuild, an approximate time remaining appears on the administration page (Fig. 58). The drive may also reboot, in which case you will need to log in again to continue administration.

Rebuild times:

The following chart shows the approximate time it takes to convert from a RAID 0 array to another mode.

New Mode	Total Size	Approx. Time
RAID 0	Any	3 minutes
RAID 1	1TB	2 hours
RAID 1	2TB	4 hours

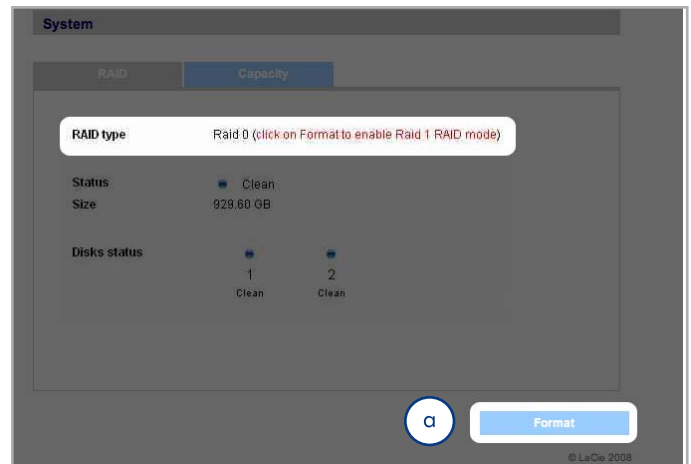

Fig. 57



Fig. 58

4.5.5. Disks

Attached external hard drives and their partitions appears as shares on the Browse page. See section [3.1. Accessing Shared Folders](#). Attaching external disks expands the available storage capacity through the network.

TECHNICAL NOTE: When shares are created from partitioned external hard drive volumes, they are initially named with a series of numbers and letters (a, [Fig. 59](#)). You can rename the shares on the Shares page. The name of external drives will remain on the Shares page even when the disk is not connected.

Once the drive is recognized, users can be assigned access just like other shares (by default, users will have read/write access). See section [4.2. Users](#).

Formatting External Disks

In order to use an external drive to back up the 2big Network, it must be formatted in FAT32 (4GB file size limitation), FAT (2GB file size limitation), HFS+, EXT3, EXT2, REISERFS or XFS. NTFS volumes cannot be used to back up the 2big Network because this file system format is read-only when connected to the 2big Network.

It is possible to format external volumes into the XFS file system using the 2big Network Web Administration pages. To format disks in XFS from the Web Administration pages, click System > External disks and click the **Format disk** button (b, [Fig. 59](#)). The disk will subsequently become available for backups. See [4.7. Backup](#) for details.

IMPORTANT INFO: After reformatting a disk, you may have to reboot the 2big Network and/or the USB hard drive in order for it to be recognized by the system.

continued on the next page

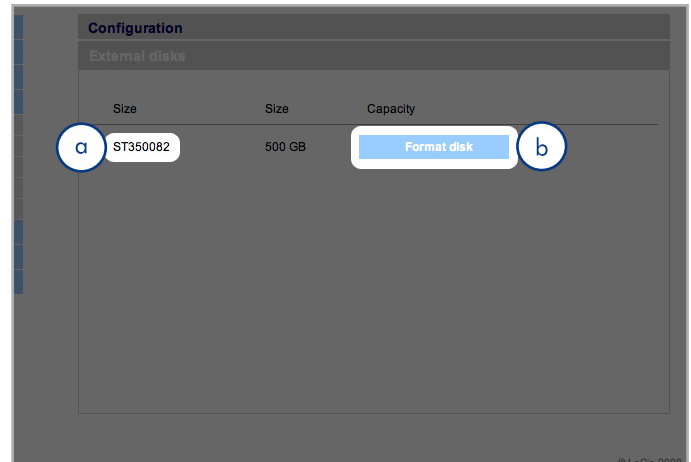

Fig. 59

Partitions

If the external drive is partitioned, each volume will appear as one share in the 2big Network (Fig. 60). By default, services (except FTP) are activated. Added shares can thus be accessed in an Explorer window (Windows users) or in a Finder window (Mac users, Fig. 60).

In Fig. 61, the volumes “LaCie1” and “LaCie2” (a) are volumes of a partitioned external hard drive that is not connected to the 2big Network, as indicated by the gray Status indicator (c) and italicized text. The volumes “Scranton” and “Stamford” (b) are volumes of an external drive that is currently connected, as indicated by the blue Status indicators.

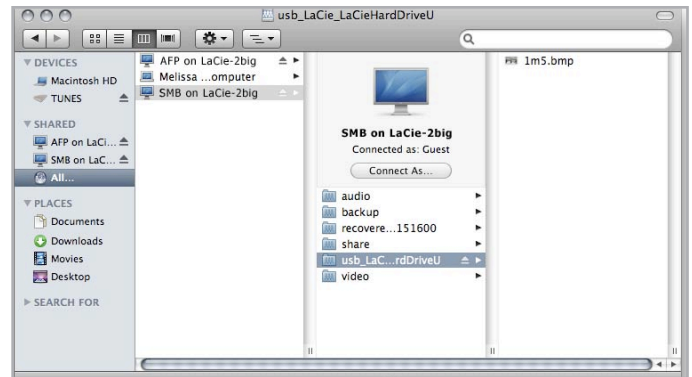

Fig. 60

IMPORTANT INFO: External hard disks must be formatted in one of the supported systems in order to mount on the LaCie 2big Network: FAT32, FAT, NTFS, HFS+, EXT3, EXT2, REISERFS or XFS.

Note that you can reformat external drives to the XFS file system using the 2big Network web interface.

However, the following limitations apply: NTFS disks are read-only, and FAT/FAT32 disks have file size limits (2GB and 4GB, respectively) due to their file system limitations.

Ejecting External Disks

To disconnect an external hard drive from the 2big Network, simply click the **Eject** button on this page (Fig. 62).

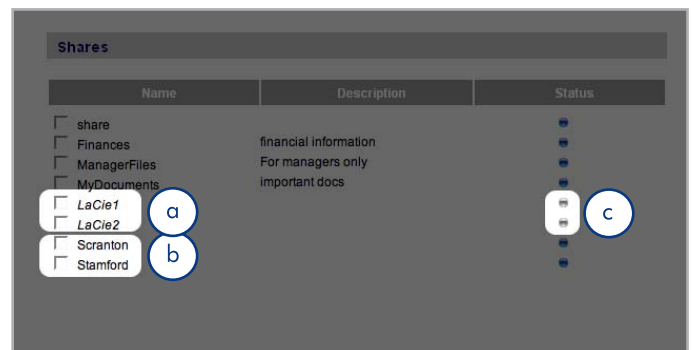

Fig. 61

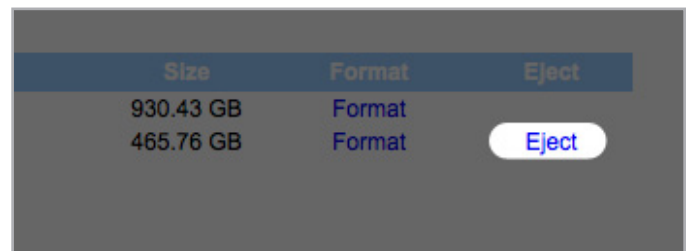

Fig. 62

4.5.6. Status

Click on **Status** under **System** in the navigation bar to display the system Status page (Fig. 63).

On this page you can view the number of connected users, disable file server services (SMB, AFP, and FTP) and view, download or delete the system log. To disable a service, simply click the **Disable** button that corresponds to the service which you wish to disable, or deselect it.

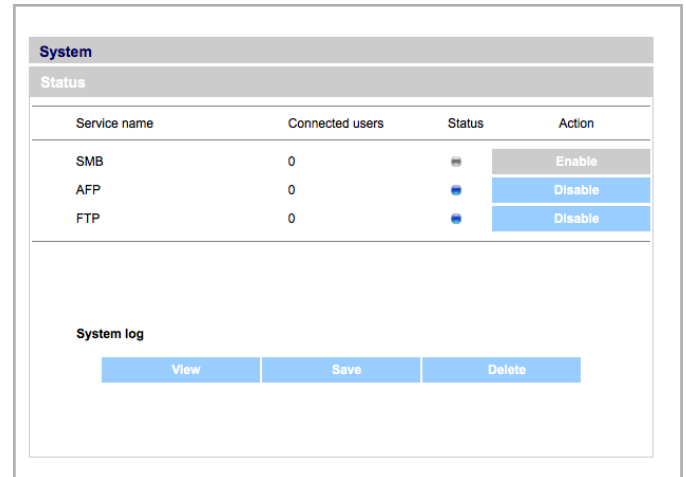

Fig. 63

4.5.7. Maintenance

Click on **Maintenance** under **System** in the navigation bar to display the Maintenance page (Fig. 64).

On this page you can view basic system information, manage updates, restart or shutdown the system (only if the power switch is in the AUTO position) and load new system configurations.

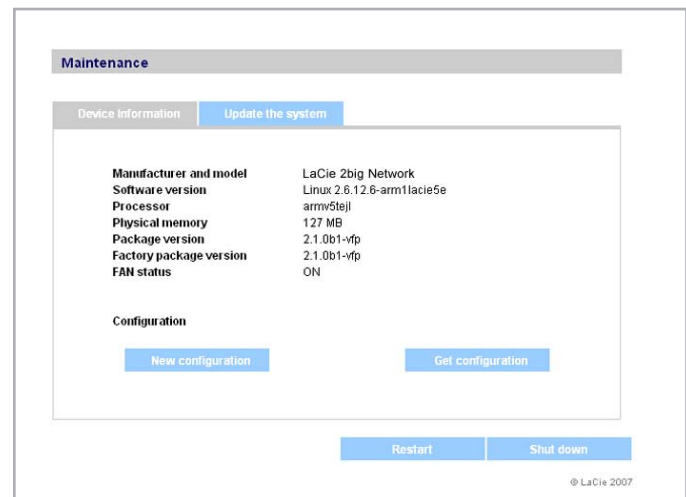

Fig. 64

4.5.7.1. Saving and Loading System Configurations

It's a good idea to save your system configuration in case the 2big Network needs to be reformatted or reset. You can then reload the configuration so that your settings, shares, groups and users are not lost.

IMPORTANT INFO: Share content (files) is not saved in a configuration file.

To save the current configuration:

1. Click on **System** and then **Maintenance**.
2. Click the **Get Configuration** button (Fig. 65). When the confirmation dialog opens, click **Save File**.

Internet Explorer users: The XML defining the configuration will open in the browser window. To save the configuration, select **File > Save as...** In the **Save as type** menu in the Save As dialog, select **XML Files (*.xml)** and choose a location to save the file.

Firefox and Safari users: Your browser will save the file to the browser's default download location. The configuration file is an XML file.

IMPORTANT INFO: Do not save configuration files on the 2big Network alone. If data loss occurs, the configuration file may also be lost.

To load a saved configuration:

1. Click on **System** and then **Maintenance**.
 2. Click the **New Configuration** button (Fig. 66).
 3. Click **Browse...** and select a configuration file from your computer.
 4. Click **Apply**.
-

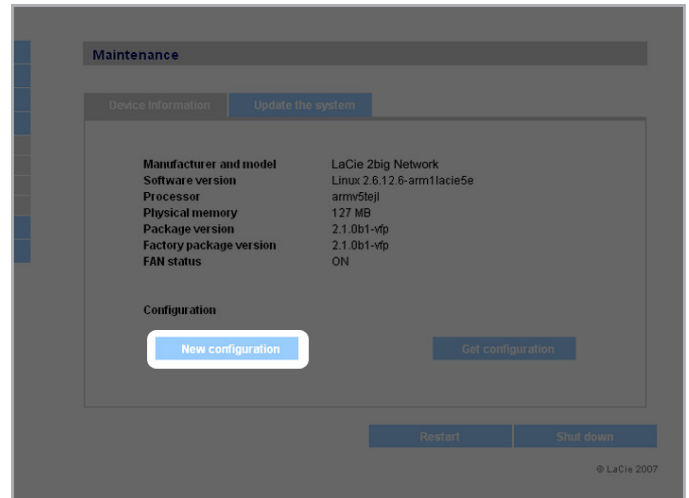

Fig. 65

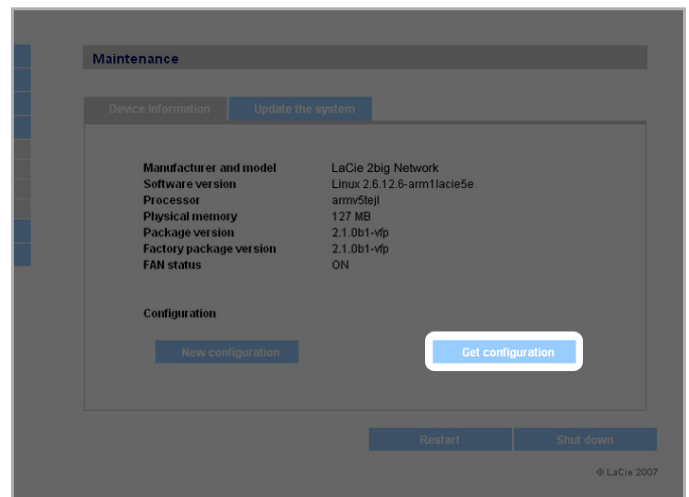

Fig. 66

4.5.7.2. Updating the System

Firmware updates may become available for the 2big Network.

To install firmware updates:

1. Download updates from www.lacie.com/support/downloads/.
2. Click the **Update the system** tab in Maintenance (a, [Fig. 67](#)).
3. Click **New Update** (b, [Fig. 67](#)).
4. Click **Browse...** and select an update file from your computer.
5. Click **Apply**.

During the system update you will not have access to the device and users will not be able to access shares. When the update is complete, the login page will open.

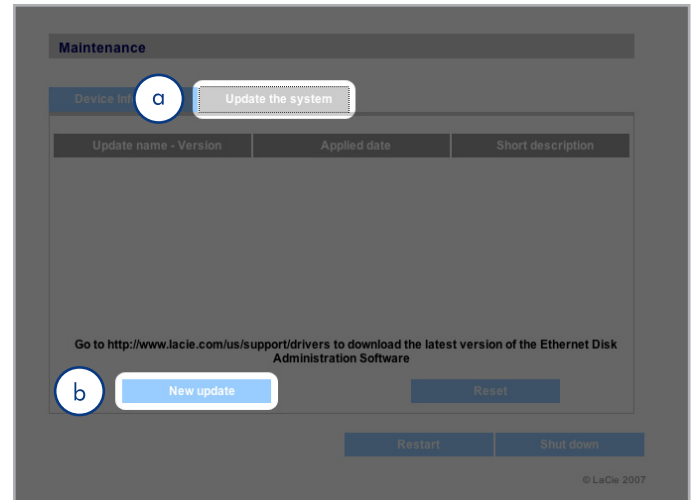

Fig. 67

4.5.7.3. Restart

To restart the 2big Network, click the **Restart** button ([Fig. 68](#)). The restart process takes a few minutes. When the machine has restarted, the login page will open.

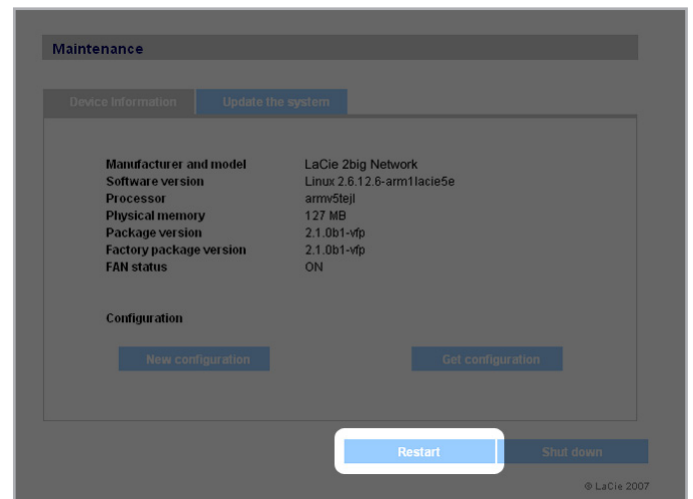

Fig. 68

4.5.7.4. Shut Down

There are two ways to disconnect the Ethernet connection:

- ◆ Move the power switch to the **off** position. The system will shut down and power off. When the shutdown process is complete, you can safely remove the Ethernet cable.
- ◆ Click the **Shut Down** button (Fig. 69). This option is available ONLY if the power switch is set to the AUTO position.

IMPORTANT INFO: Any data transfers underway during a shut down will be interrupted and data may be lost. Make sure no users are connected or transferring data to or from the 2big Network before shutting down.

4.5.8. System Log

The system log allows you to review the type, date, time, source and event ID of activities on the LaCie 2big Network (Fig. 70).

To view the system log, select **System > Status > View**.

Click **Download** to download the log or **Delete** to clear its contents.

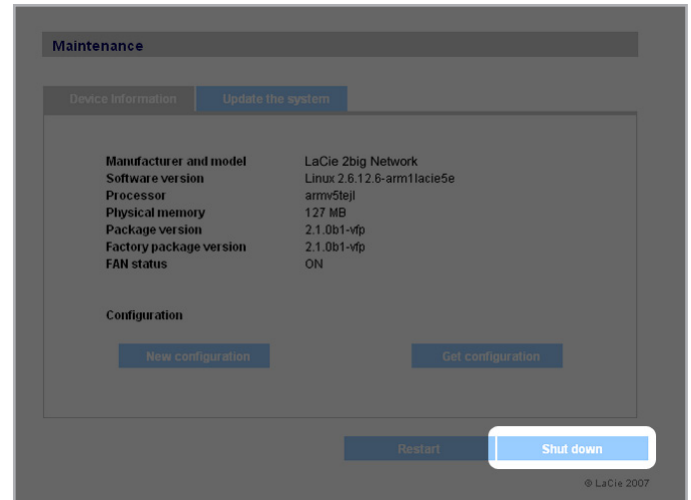

Fig. 69

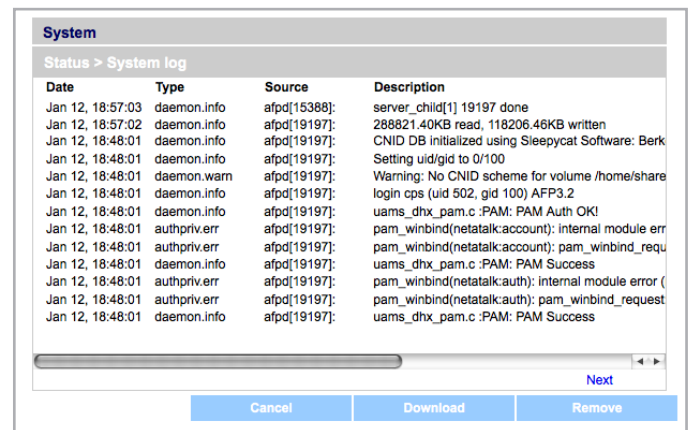

Fig. 70

4.5.9. Wake on LAN (WOL)

This function enables you to enable waking the 2big Network remotely on the local area network (LAN). For WOL to work, the power switch must be in the AUTO position. This function is accessed using the LaCie Network Assistant software. Follow these steps to activate WOL:

1. Click the LNA icon in your menu bar (Mac Users, [Fig. 71](#)) or your task bar (Windows users) and click **Wake Up a Device...**
2. In the window that opens ([Fig. 72](#)), select the device and click **Wake up**.



Fig. 71

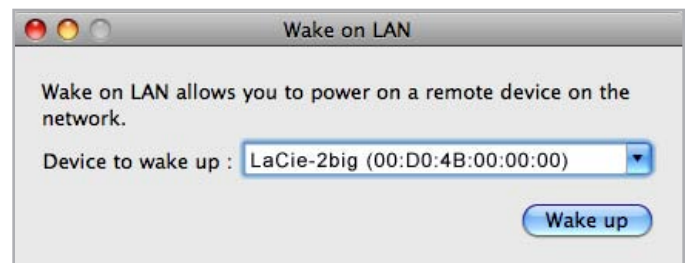

Fig. 72

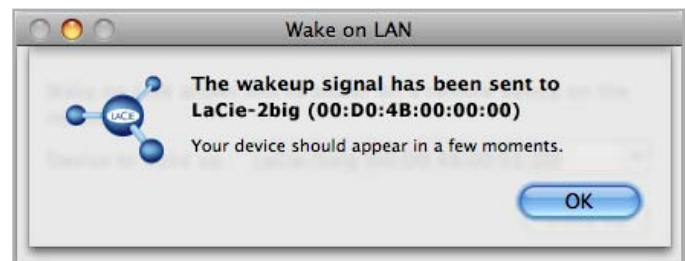

Fig. 73

4.6. Download

The LaCie 2big Network has the capability to act as a torrent client. **Torrent** is a peer-to-peer file sharing system used to share large files. Those in possession of a file act as seeders, and those who download files are peers. Because peers simultaneously upload already downloaded portions as they download and because of the decentralized nature of the system, the torrent protocol reduces bandwidth and hardware costs associated with sharing large files through the internet.

Torrent files, which are freely available on the internet, contain tracking information and metadata about the files to be shared. The process of downloading files using torrents involves downloading a torrent file using your PC/Mac and importing it into a torrent client (in this case, the 2big Network).

Access the Download menu by clicking the **Download** tab in the left navigation menu.

Enabling and Initiating Torrent Downloads

1. Enable the service by clicking the **Start Server** button (Fig. 74).
2. Add a torrent by clicking the **Add Torrent** button (Fig. 75) In the page that opens, click **Browse** to select a valid .torrent file located on your computer, rename the torrent file (optional), and select the directory where the download will be saved (Fig. 76).

Configuring the Bittorrent Function

1. To configure the bittorrent capability of your 2big Network, click the **Configuration** button on the navigation menu on the left of the page (Fig. 77).
2. Modify the available parameters and click the **Save Settings** button.

TECHNICAL NOTE: Because the torrent client service uses bandwidth and system resources, multiple simultaneous downloads can impact 2big Network performance.

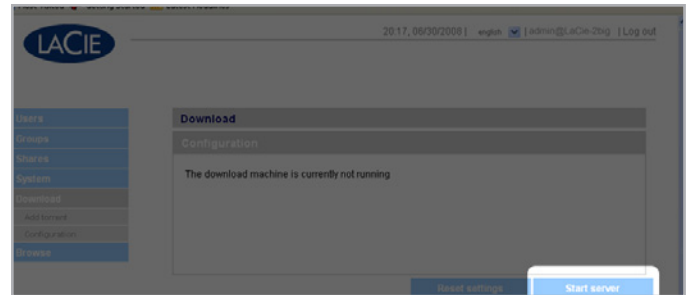

Fig. 74

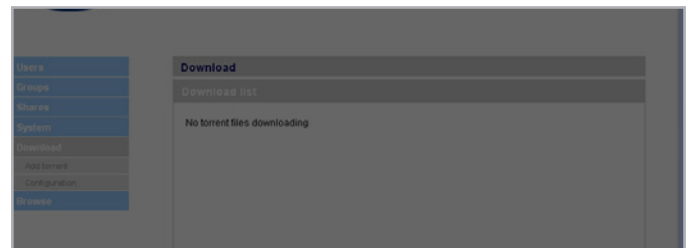

Fig. 75

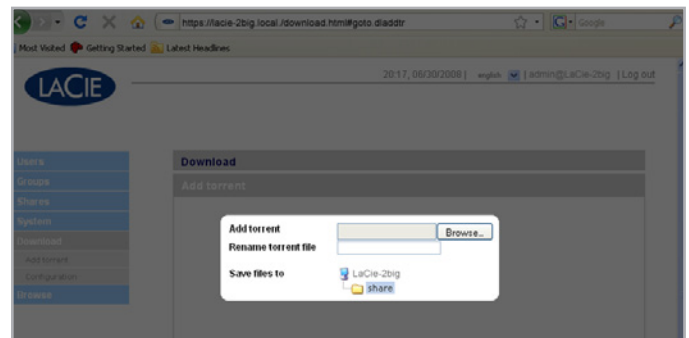

Fig. 76

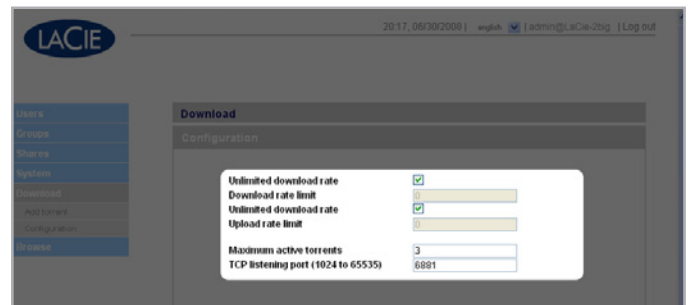

Fig. 77

4.7. Backup

When an external USB hard disk is connected to your LaCie 2big Network, you can perform manual, bidirectional backups of your files. Copy files from your LaCie 2big Network to the external disk, or from the external disk to the LaCie 2big Network.

IMPORTANT INFO: In order to use an external drive to back up the 2big Network, it must be formatted in one of the supported systems: FAT32, FAT, NTFS, HFS+, EXT3, EXT2, REISERFS or XFS.

Note that you can reformat external drives to the XFS file system using the 2big Network web interface. See [4.5.5. Disks](#) for formatting steps.

However, the following limitations apply: NTFS disks are read-only, and FAT/FAT32 disks have file size limits (2GB and 4GB, respectively) due to their file system limitations.

To back up files:

1. Connect an external USB hard disk (see section [3.4. Connecting External Hard Disks](#)).
2. Log in to the LaCie 2big Network Administration Page (see section [4.1. Accessing the Administration Page](#)).
3. Click **Backup** > **Add Task** ([Fig. 78](#)).
4. Give the backup a name and set its frequency (once, daily, weekly, or monthly) and time (if the backup is recurring) ([Fig. 79](#)) and click **Next**.
5. Select a source folder (the folder to be backed up) and click **Next**.
6. Select a destination folder (where the backed up files will be located) and click **Next**.
7. Click **Add job**.

TECHNICAL NOTE: If copying a share to an external disk, the entire contents of the share will be copied to a folder on the external disk with the same name as the share.

continued on the next page



Fig. 78

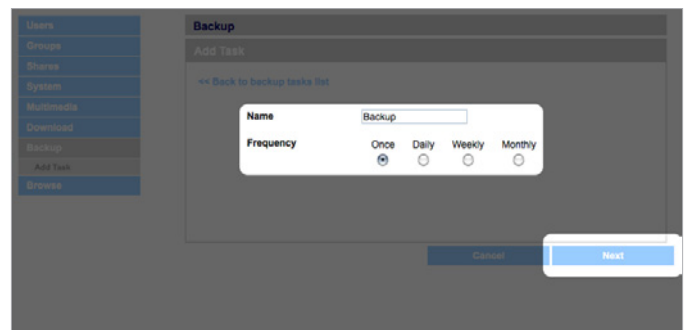

Fig. 79

8. If the frequency is set to “Once,” the backup will begin after a few seconds. An in-progress backup will be indicated with yellow highlighting (Fig. 80).
9. Successful backups will no longer be highlighted and will show the date the backup was last completed (Fig. 81).

TECHNICAL NOTE: Backups are incremental, which means that future backups will only copy new or modified files.

TECHNICAL NOTE: Backed up data is neither compressed nor encrypted, and can be accessed from other computers or NAS (network-attached storage).

4.8. Browse

Refer to section 3.3. *Administration Page – Browse* for details.

4.9. Import (Snapshot)

When you plug an external device to one of the 2big Network’s ports and push the front button, the 2big Network will automatically import (take a snapshot of) the data from the external device. The imported data will be copied into an automatically created share with a unique name (Fig. 82).



Fig. 80

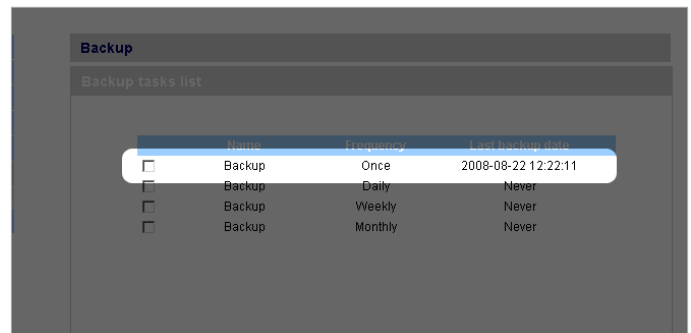

Fig. 81

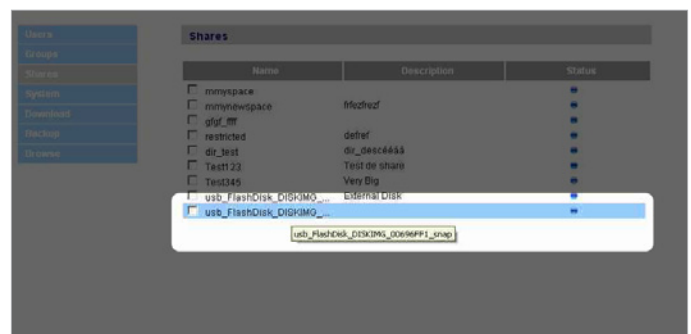

Fig. 82

4.10. Multimedia

Thanks to its support of UPnP A/V and DLNA protocols, the d2 Network can act as a multimedia server, providing access to its files to compliant digital media appliances. Such appliances include Playstation 3, Xbox360, many LCD TV and stereos, or Digital Media Adapters (DMA).

To activate the UPnP and DLNA protocols, follow these steps:

1. Navigate to the **Multimedia** tab on the Administration page and check the **Enable Multimedia Content Sharing** [Fig. 83](#).
2. Select which share(s) you would like to share with wireless devices.
3. Check the **Rescan files** box.
4. Click **Apply**.

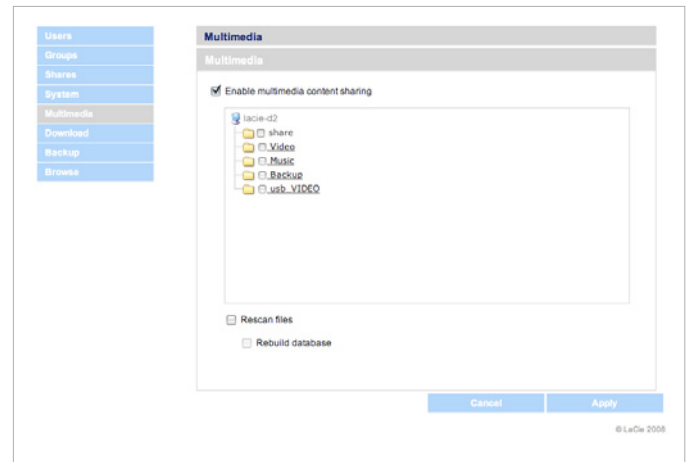

Fig. 83

5. RAID and Disks

The LaCie 2big network supports RAID levels 0 (default) and RAID 1. Please see sections [5.2. RAID 0](#) and [5.3. RAID 1](#) for detailed information on 2big RAID levels. The following chart sums up the strengths and weaknesses of each RAID level.

See section [5.4. Installing a New Disk](#) for information on removing and installing hard disks.

RAID Mode	Capacity	Protection
RAID 0	100%	★★★★★
RAID 1	50%	★★★★★

5.1. Changing the RAID Level

Refer to section [4.5.4. RAID](#).

IMPORTANT INFO: 1GB = 1,000,000,000 bytes. 1TB = 1,000,000,000,000 bytes. Once formatted, the actual available storage capacity varies depending on operating environment (typically 10-15% less). For example, if the total disk size is 500 GB, the formatted capacity should be approximately 465 GB. If the used capacity is 145 GB, remaining capacity will be 320 GB.

5.2. RAID 0

RAID 0 (also called Spanning mode in some LaCie devices), is the fastest RAID mode. In a RAID 0 array, the available capacities of each disk are added together so that one logical volume mounts on the computer (Fig. 84).

If one physical disk in the array fails, the data of all disks becomes inaccessible because parts of the data have been written to all disks.

Applications

RAID 0 is ideal for users who need maximum speed and capacity. Video editors working with very large files may use RAID 0 when editing multiple streams of video for optimal playback performance. A RAID 0 array is more suited for actively working with files (editing video, for example) and should not be used as a single storage backup solution or on mission critical systems.

How RAID 0 Capacity Is Calculated

Each disk in a RAID 0 system should have the same capacity.

Storage capacity in a RAID level 0 configuration is calculated by multiplying the number of drives by the disk capacity, or $C = n*d$, where:

C = available capacity

n = number of disks

d = disk capacity

For example, in a RAID 0 array with four drives each with a capacity of 1000GB, the total capacity of the array would be 4000GB:

$C = (4*1000)$

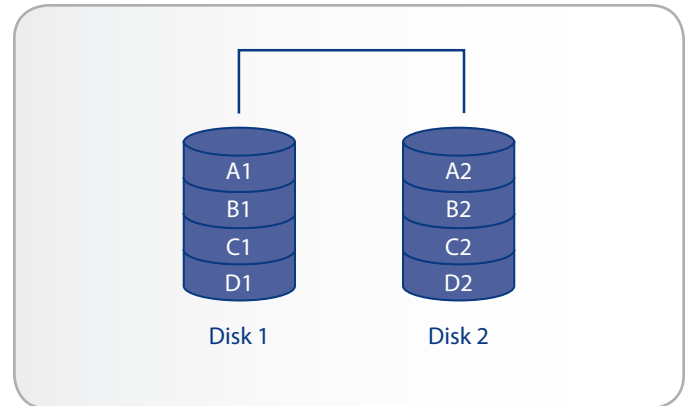

Fig. 84

5.3. RAID 1

RAID 1 is a secure RAID mode that requires at least 2 drives and works with pairs of drives (Fig. 85). One logical volume mounts on the computer and the combined available capacity of both drives is limited to the capacity of the lowest-capacity disk. If one physical disk fails, the data is available immediately on the second disk. No data is lost if one disk fails.

Applications

RAID 1 provides maximum data safety in the event of a single disk failure, but because data is written twice, performance is reduced slightly when writing. RAID 1 is a good choice when safety is more important than speed.

How RAID 1 Capacity Is Calculated

Each disk in a RAID 1 system should have the same capacity.

Storage capacity in a RAID level 1 configuration is calculated by multiplying the number of drives by the disk capacity and dividing by 2, or

$$C = n*d/2$$

where:

C = available capacity

n = number of disks

d = disk capacity

For example, in a RAID 1 array with four drives each with a capacity of 1000GB, the total capacity of the array would be 2000GB:

$$C = (4*1000)/2$$

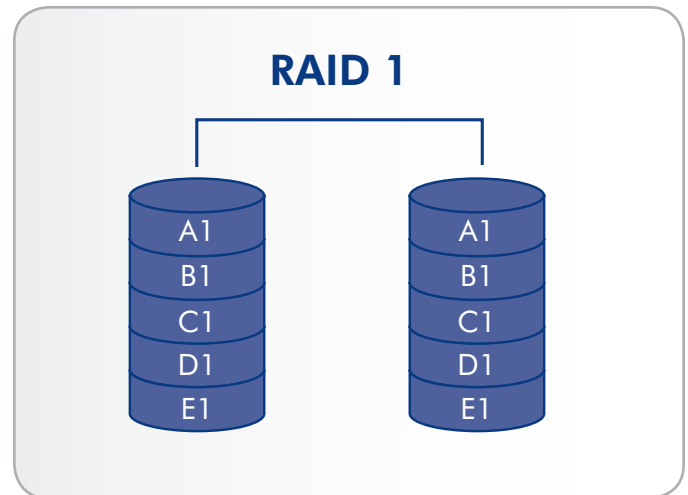

Fig. 85

5.4. Installing a New Disk

To remove a disk:

1. The drive tray may be locked. To unlock it, use the 2-in-1 RAID mode change and drive lock tool to turn the lock until the slot is vertical (Fig. 86).
2. Draw out the drive tray by inserting your finger into the space behind the drive tray handle and pulling to disengage the drive (Fig. 87).
3. Grasp the drive tray handle and carefully extract the drive (Fig. 88).

To install a disk:

Replacing a drive involves two main steps, installing the new drive and initializing the new disk on the **System > RAID** page (see below).

CAUTION: After continuous use of the LaCie 2big network, drives may be hot. Use caution when removing.

1. Carefully insert the drive tray into an empty drive bay. When the drive tray is most of the way in and you feel resistance, press the drive tray handle firmly until you feel the drive snap into place and the drive tray handle is flush with the back of the 2big.
2. Use the 2-in-1 RAID mode change and drive lock tool to unlock the drive.
3. In the System > RAID page, you will see a message indicating that the system has recognized a new disk and requesting user validation.
4. The new disk will be added as a spare or as a part of a RAID array and will begin to rebuild.

IMPORTANT INFO: In the event that an individual hard disk fails in the LaCie 2big network, please contact your LaCie reseller or LaCie Customer Support. Please replace a defective hard drive only with a new drive provided by LaCie.

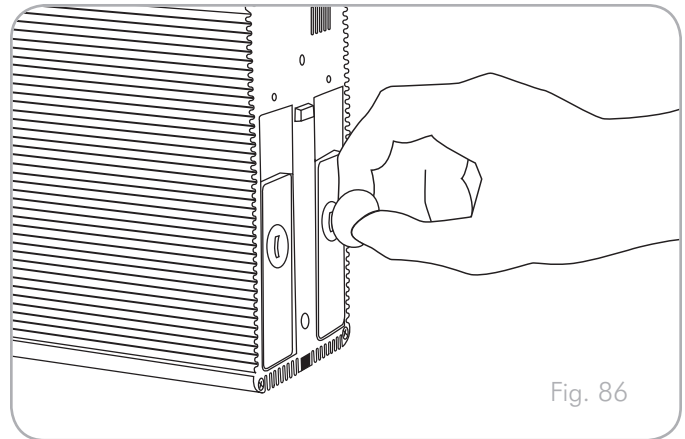

Fig. 86

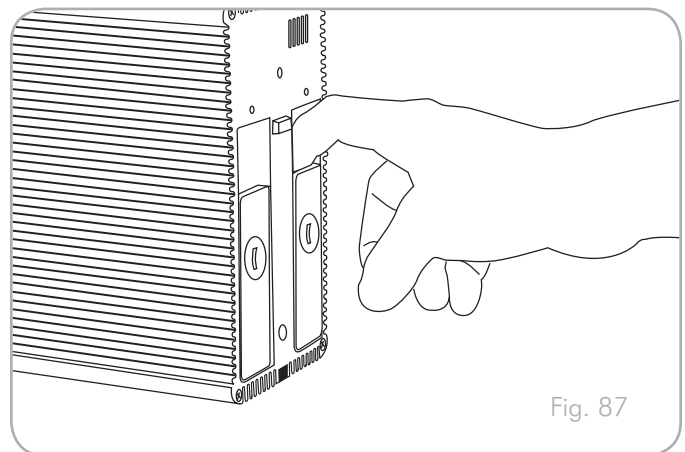

Fig. 87

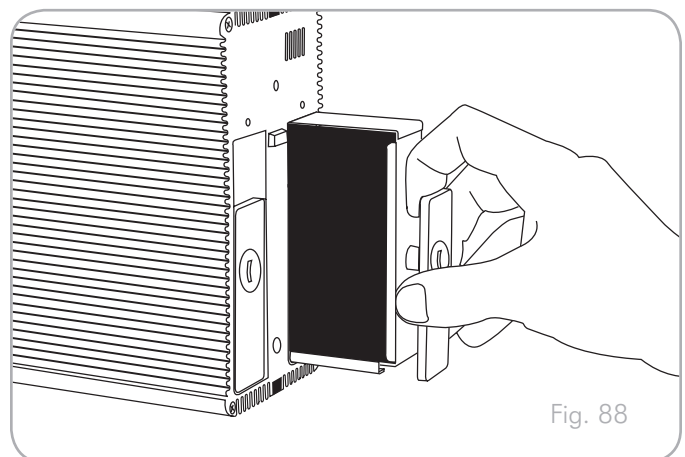





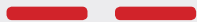

Fig. 88

6. LED Indicators

The LED indicators above the drive bays and the front LED indicate drive status and activity. This section describes the behavior of the LED indicators.

Front LED Color	Rear LED Color	2big Network State
Solid blue 	Activity LED for working disk(s) 	Drive working (read/write)
Blinking blue (0.8s, 0.8s) 	Activity LED for working disk(s) (until they are fully initialized) 	Occurs as the 2big Network is booting; will cease once the drives are fully initialized
Long blue (2.5s), short pause (0.25s) 	Activity LED for working disk(s) 	RAID building; will cease once operation has concluded
	Activity LED for working disk(s)  Long blue (2.5s), short red (0.25s) in rebuilding disks 	RAID rebuilding after new disk inserted; will cease once it has rebuilt
	Activity LED for working disk(s) 	Backup/import operation in progress; will cease once operation has concluded
Long blue (2.5s), short red (0.25s) 	Activity LED for working disk(s) only  Solid red for non-functional disks 	Damaged RAID; system working but non-functional disks need to be replaced
Blinking red (0.3s/0.3s) for 3 seconds total 	Activity LED for working disk(s) 	During a backup operation, the external disk is full or not formatted During an import operation (triggered by pressing the front blue button), the external disk is empty
Solid red 	Solid blue in functional disks  Solid red in non-functional disks 	Drive failure, RAID broken, data lost
	N/A	System broken or not found.

continued on the next page

Front LED Color	Rear LED Color	2big Network State
Blinking blue/red (0.3s, 0.3s) 	Activity LED for working disk(s) 	Temperature alert (first level)
Solid red until it goes to Stand by, then OFF 	N/A	Temperature alert (critic level) – the product will switch to stand by mode
Long red (2.5s), short pause (0.25s) 	Activity LED for working disk(s) 	Fan is not rotating

7. Email Notification Triggers

RAID Manager	Download Machine	Fan Controller	Snapshot
1. Build started	1. Download completed	1. Fan failed	1. Error creating share
2. Build completed		2. Fan now works	2. No external devices detected
3. Spare active		3. High temperature	3. External device not yet mounted
4. Spare failed		4. Critical temperature	4. Error copying
5. Disk failed/disappeared		5. Fan controller problem	5. Copy successful
		6. No temperature sensed	

8. Troubleshooting

In the event that your LaCie 2big Network is not working correctly, please take a look at the Troubleshooting section on the following pages and at the FAQs published on our web site – www.lacie.com. One of these FAQs may provide an answer to your specific question. You can also visit the downloads page, where the most recent software updates will be available – www.lacie.com/support/downloads.

If you need further assistance, please contact your LaCie reseller or LaCie Technical Support (see chapter 9. *Contacting Customer Support* for details).

System Log

The system log allows you to review the type, date, time, source and event ID of activities on the LaCie 2big Network. For more information, refer to chapter 4.5.8. *System Log*.

Manual Updates

LaCie strives to give you the most up-to-date, comprehensive user manuals possible. It is our goal to provide you with a friendly, easy-to-use format that will help you quickly install and utilize the many functions of your new device.

If your manual does not reflect the configurations of the product that you purchased, please check our website for the most current version available.

www.lacie.com

Problem	Question to Ask	Solution
The system is not recognized by the computer.	Does your computer's configuration meet the minimum system requirements?	Check section 1.2. <i>Minimum System Requirements</i> for more information.
	Is the system's power supply connected and is the blue light on the front of the drive on?	Make sure that the power supply is properly connected (see section 2.1. <i>Turning on the 2big Network</i> for details); that the system has been powered on by moving the power switch on the back of the device to the ON position; and that the outlet the power supply is connected to is powered on or has a sufficient supply of power.
	Is the blue light on the front of the device flickering?	If the blue light is flickering or will not turn on, the power supply may be defective. Please contact your LaCie reseller or LaCie Customer Support.
	Did you follow the correct installation steps?	Review the installation steps (2. <i>Setting Up Your LaCie 2big Network</i>).
	Are both ends of the Ethernet cable firmly connected?	Disconnect the Ethernet cable, wait 10 seconds and then reconnect. Ensure that the interface connectors are properly aligned. The Ethernet cable can only be inserted one way. Make sure it is correctly oriented. Check that the Ethernet connectors are straight and fully seated in the Ethernet ports. Make sure that you use the Ethernet cord provided in the 2big Network box.

Problem	Question to Ask	Solution
<p>The system doesn't appear on the network.</p>	<p>By default the 2big Network is configured to retrieve its IP address from a DHCP server. If your network is managed by a DHCP server and you cannot access your 2big Network, try checking your DHCP server's log. To get the IP address, run LaCie Network Assistant, which is located on the LaCie Storage Utilities CD-ROM. If your network is NOT managed by a DHCP server, the 2big Network uses its default IP address, which is 192.168.xx.100. To change this IP address, use LaCie Network Assistant.</p>	
	<p>Is the IP address properly set?</p>	<p>For more information, please see section 3.1. Accessing Shared Folders.</p>
	<p>Is your network DHCP enabled?</p>	<p>If your network is DHCP enabled, please refer to sections 2.3. Connecting Using LaCie Network Assistant. If your network is not DHCP enabled, you will need to manually configure the address; please see section 2.4. Configuring the LaCie 2big Network on a Network Without a DHCP Server.</p>
	<p>Are you using AppleTalk under Mac OS 9.x?</p>	<p>If you are using AppleTalk under Mac OS 9.x, ensure that the LaCie 2big Network and the other clients on the network are in the same AppleTalk zone.</p>
<p>A user does not have access to the LaCie 2big Network.</p>	<p>Has the administrator created an account for the user?</p>	<p>In order for a another user to access the LaCie 2big Network, two conditions must be met: 1) the administrator must create and register a user with the appropriate privileges; 2) the LaCie 2big Network must be connected to the network via Ethernet for additional users to access the drive.</p>

9. Contacting Customer Support

Before You Contact Technical Support

Read the User Manual and review the Troubleshooting section.

Try to isolate the problem. If possible, make the drive the only external device on the CPU, and make sure that all of the cables are correctly and firmly attached.

If you have asked yourself all of the pertinent questions in the troubleshooting checklist, and you still can't get your LaCie drive to work properly, contact us via the contacts on the following page. Before contacting us, make sure that you are in front of your computer and that you have the following information on hand:

Information	Where to Find Information
LaCie 2big Network serial number	Located on a sticker at the back of drive or on the original packaging
LaCie 2big Network file format	Mac users: Select the hard drive icon and press Command + I, or press the Control key and choose Get Info . Windows users: Right click the hard drive icon and select Properties .
Macintosh/PC model	Mac users: Click on the Apple icon in the menu bar and select About this Mac . Windows users: Right click My Computer and select Properties > General .
Operating system version	
Processor speed	
Computer memory	
The brands and models of other internal and external peripherals installed on my computer	Mac users: Click on the Apple icon in the finder bar and select About this Mac . Select More Info... The Apple System Profiler will launch and will list your internal and external peripherals. Windows users: Right click My Computer and select Properties > Hardware .

8.1. LaCie Technical Support Contacts

LaCie Asia, Singapore, and Hong Kong Contact us at: http://www.lacie.com/asia/contact/	LaCie Australia Contact us at: http://www.lacie.com/au/contact/
LaCie Belgium Contact us at: http://www.lacie.com/be/contact/ (Français)	LaCie Canada Contact us at: http://www.lacie.com/caen/contact/ (English)
LaCie Denmark Contact us at: http://www.lacie.com/dk/contact	LaCie Finland Contact us at: http://www.lacie.com/fi/contact/
LaCie France Contact us at: http://www.lacie.com/fr/contact/	LaCie Germany Contact us at: http://www.lacie.com/de/contact/
LaCie Italy Contact us at: http://www.lacie.com/it/contact/	LaCie Japan Contact us at: http://www.lacie.com/jp/contact/
LaCie Netherlands Contact us at: http://www.lacie.com/nl/contact/	LaCie Norway Contact us at: http://www.lacie.com/no/contact/
LaCie Spain Contact us at: http://www.lacie.com/es/contact/	LaCie Sweden Contact us at: http://www.lacie.com/se/contact
LaCie Switzerland Contact us at: http://www.lacie.com/chfr/contact/ (Français)	LaCie United Kingdom Contact us at: http://www.lacie.com/uk/contact/
LaCie Ireland Contact us at: http://www.lacie.com/ie/contact/	LaCie USA Contact us at: http://www.lacie.com/contact/
LaCie International Contact us at: http://www.lacie.com/intl/contact/	

10. Warranty Information

LaCie warrants your drive against any defect in material and workmanship, under normal use, for the period designated on your warranty certificate. In the event this product is found to be defective within the warranty period, LaCie will, at its option, repair or replace the defective drive. This warranty is void if:

- ◆ The drive was operated/stored in abnormal use or maintenance conditions;
- ◆ The drive is repaired, modified or altered, unless such repair, modification or alteration is expressly authorized in writing by LaCie;
- ◆ The drive was subjected to abuse, neglect, lightning strike, electrical fault, improper packaging or accident;
- ◆ The drive was installed improperly;
- ◆ The serial number of the drive is defaced or missing;
- ◆ The broken part is a replacement part such as a pickup tray, etc.
- ◆ The tamper seal on the drive casing is broken.

LaCie and its suppliers accept no liability for any loss of data during the use of this device, or for any of the problems caused as a result.

LaCie will not, under any circumstances, be liable for direct, special or consequential damages such as, but not limited to, damage or loss of property or equipment, loss of profits or revenues, cost of replacement goods, or expense or inconvenience caused by service interruptions.

Any loss, corruption or destruction of data while using a LaCie drive is the sole responsibility of the user, and under no circumstances will LaCie be held liable for the recovery or restoration of this data.

Under no circumstances will any person be entitled to any sum greater than the purchase price paid for the drive.

To obtain warranty service, call LaCie Technical Support. You will be asked to provide your LaCie product's serial number, and you may be asked to furnish proof of purchase to confirm that the drive is still under warranty.

All drives returned to LaCie must be securely packaged in their original box and shipped with postage prepaid.

IMPORTANT INFO: Register online for free technical support:
www.lacie.com/register
